

Lo strumento ideale
per il moderno
centro di revisione

The ideal product
for the advanced
PTI center

UNISYSTEM FlatBOX - Flat S

Banco prova freni a rulli universale
Universal rollers brake tester



HPA

Faip



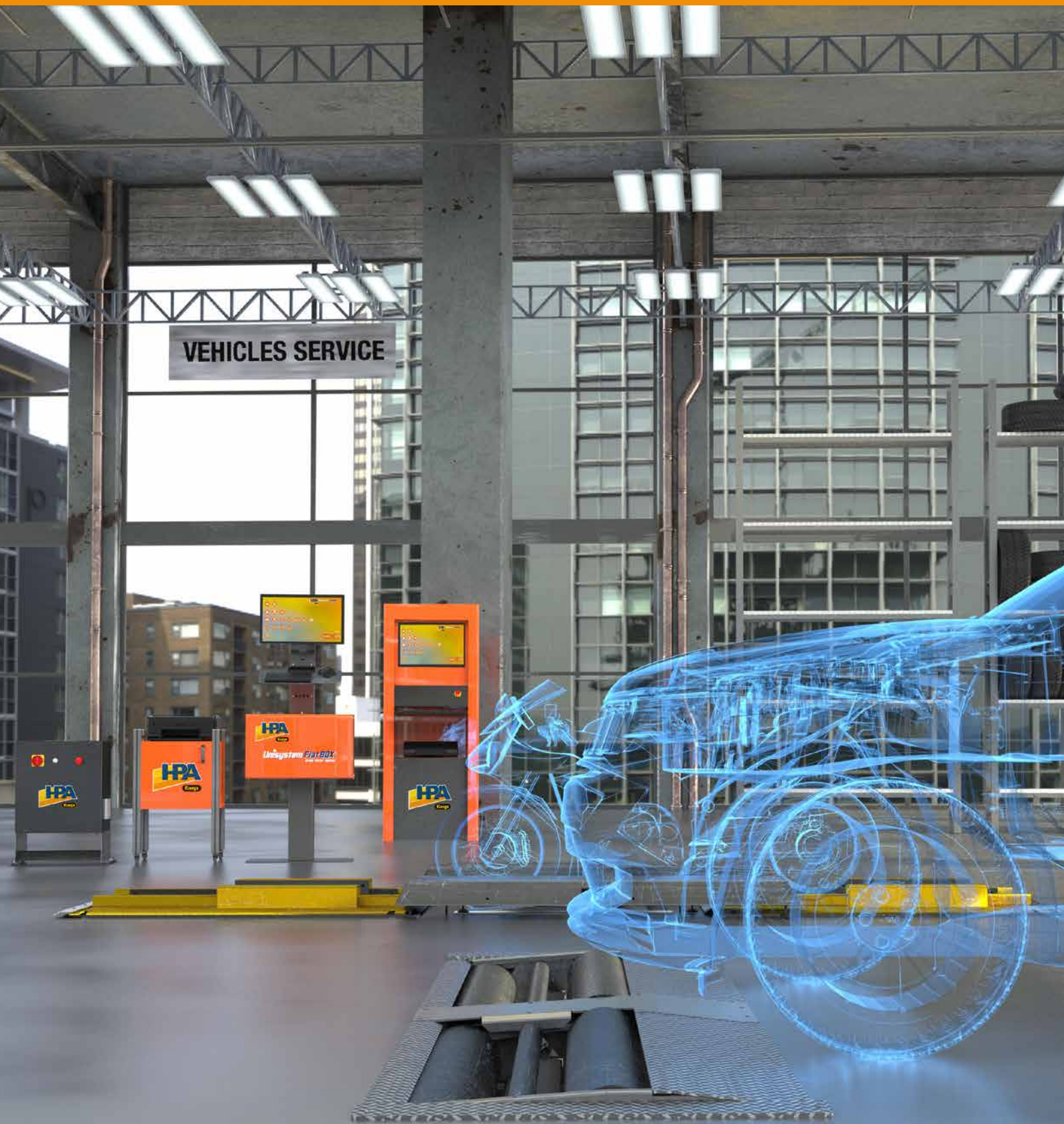

Unisystem FlatBOX,
Unisystem Flat S
con un'ampia serie di accessori
soddisfa le esigenze attuali e future
della stazione di controllo
grazie ad un approccio
pratico e flessibile.

*Unisystem FlatBOX,
Unisystem Flat S
with a wide set of accessories,
meets current and future
needs of the inspection station
thanks to a convenient
and flexible approach.*

Unisystem FlatBOX,
Unisystem Flat S
è lo strumento ideale per il moderno
centro di revisione, un nuovo banco
prova freni a rulli che in
modo semplice ed intuitivo
permette la verifica di
veicoli leggeri (sino a
3,5 t) e attraverso una
struttura modulare
anche di quelli
a 2, 3 e 4 ruote
(motoveicoli
e tricicli/
quadricicli).

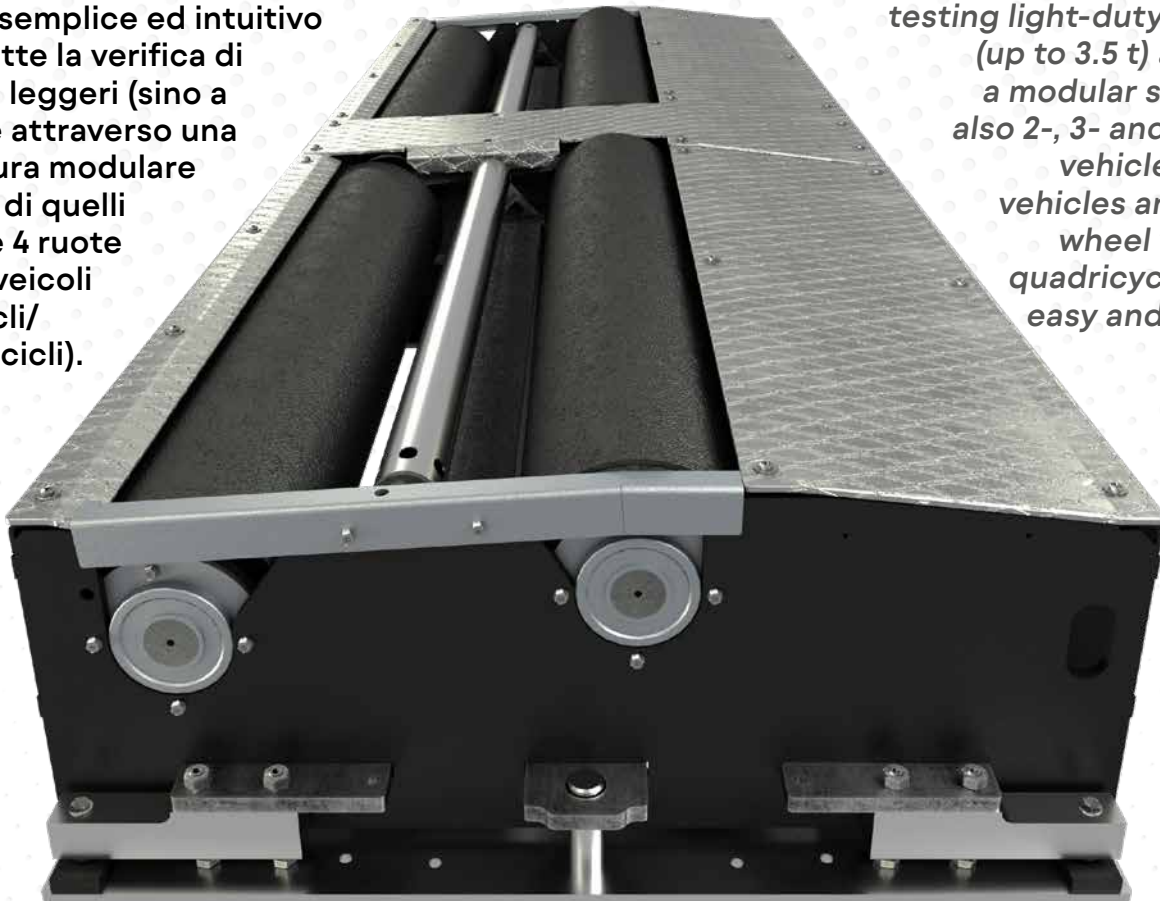

*Unisystem FlatBOX,
Unisystem Flat S
is the ideal tool for modern
overhaul centres, a new
brake test bench that allows
testing light-duty vehicles
(up to 3.5 t) and, with
a modular structure,
also 2-, 3- and 4-wheel
vehicles (motor
vehicles and three-
wheel vehicles/
quadricycles) in an
easy and intuitive
manner.*

La nuova progettazione
lo rende uno strumento
innovativo e pronto ad
accogliere le più stringenti
normative europee relative
alle prove di frenatura.



*The new design makes
it an innovative tool, ready
for compliance with the
most stringent European
regulations on braking
tests.*

Pienamente rispondente
alla normativa MTCNet 2
in configurazione DIR e
RETE, con il nuovo software
operativo garantisce
semplicità d'uso ed
accuratezza delle misure.



*It strictly complies with
MTCNet 2 standard
in DIR and NETWORK
configuration and, thanks to
the new operating software,
ensures ease of use and
measurement accuracy.*

CARATTERISTICHE GENERALI / GENERAL FEATURES

Nuova bancata monoblocco per una maggiore robustezza, upgradabile.

New one-piece bank for greater robustness, upgradable.



Nuove coperture carrabili FastDrive.

New vehicle-accessible FastDrive covers.



Cabinato di misura MCTC.

Cabinet compliant with MCTC measures.



Nuovo cabinato di misura LCT ADV.

New cabinet compliant with LCT ADV measures.

Nuovo telecomando per una navigazione semplice e veloce.

New remote control for easy and quick browsing.



Nuovo software ad icone per un accesso diretto a tutte le funzioni.

New icon-based software for direct access to all functions.

Nuova interfaccia di navigazione con monitor touch screen.

New browsing interface with touch screen monitor.

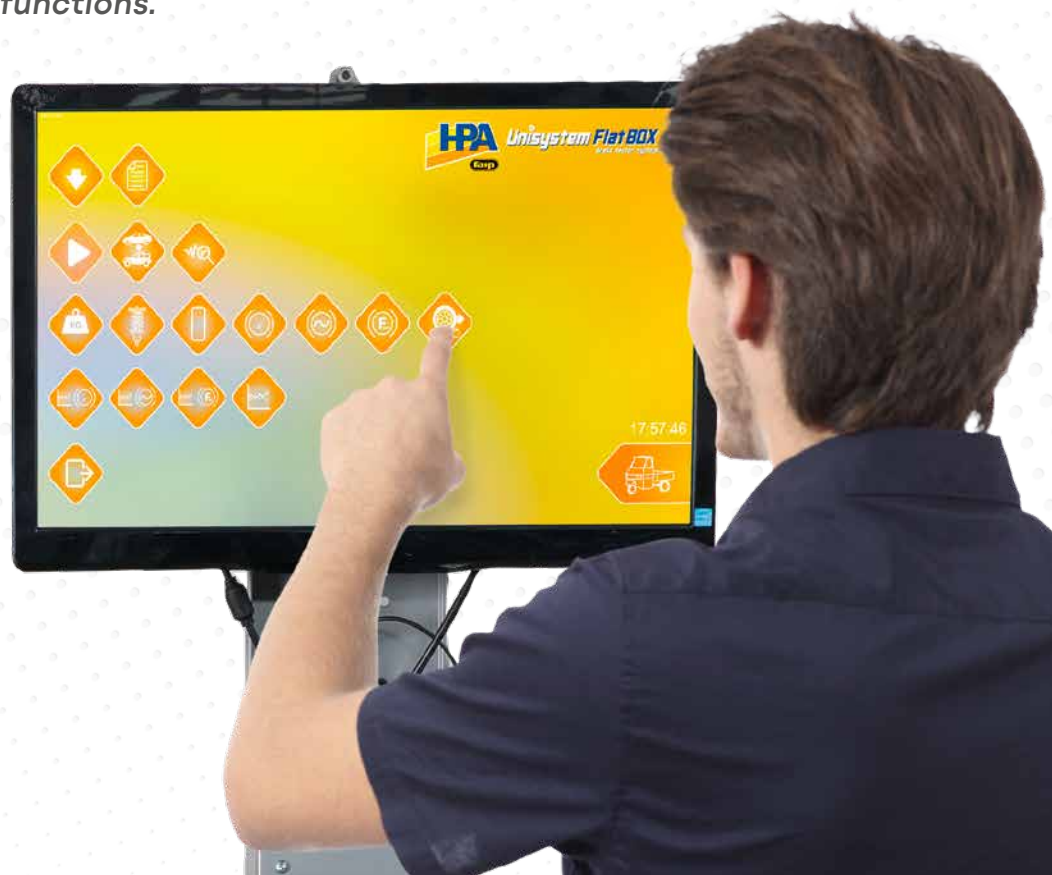

CARATTERISTICHE MECCANICHE / MECHANICAL FEATURES



RIVESTIMENTO RULLI

Il rivestimento rulli a base corindonica garantisce un corretto e durevole coefficiente di aderenza anche in caso di ruote bagnate. Il rullo posteriore è rialzato di 45 mm per garantire una maggiore stabilità durante la frenatura.

ROLLER COATING

The corundum-based roller coating ensures a correct and durable coefficient of adhesion also in case of wet wheels. The rear roller is raised by 45 mm to ensure greater stability during braking.

SISTEMA DI PESATURA SOTTO I RULLI

Il sistema di pesatura statico/dinamico è costituito da 4 celle di carico ad alta precisione per la rilevazione automatica dell'efficienza frenante.

WEIGHING SYSTEM UNDER THE ROLLERS

The static/dynamic weighing system consists of 4 high-precision load cells for braking efficiency automatic detection.

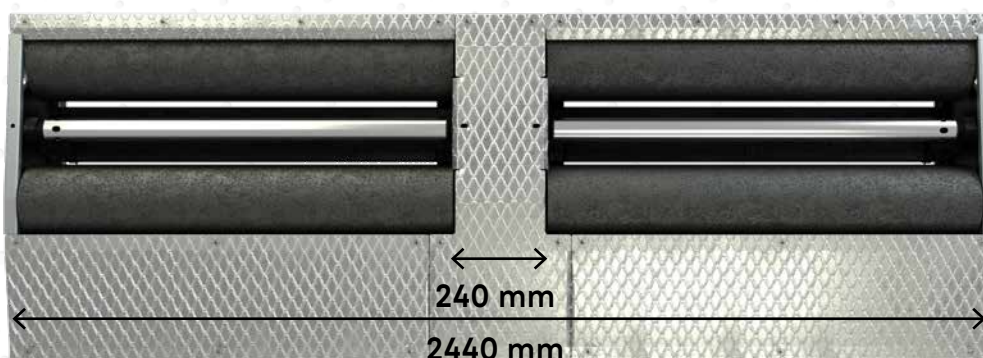

DISTANZA MINIMA INTERNA E DISTANZA MASSIMA ESTERNA DEI RULLI

Grazie alle caratteristiche costruttive è possibile testare un'ampia gamma di veicoli a quattro ruote, dai quad ai camper, senza nessuna difficoltà.

ROLLER MINIMUM INTERNAL DISTANCE AND MAXIMUM INTERNAL DISTANCE

Thanks to the construction features, it is possible to easily test a wide range of four-wheel vehicles, including quads and campers.

DETTAGLI / DETTAGLI



CORNICI DI MONTAGGIO PER FOSSA SINGOLA O PER FOSSA UNICA

È disponibile una serie completa di cornici di montaggio per installazioni singole, con il solo "prova freni", oppure in configurazione unica in abbinamento al "prova velocità".

Nelle cornici sono presenti le predisposizioni per l'installazione del sistema di calibrazione e dei marciapiedi per motoveicoli a due ruote.

MOUNTING FRAMES FOR SINGLE PIT OR UNIQUE PIT

A complete set of mounting frames is available for single installations, with "brake test" only or in unique configuration combined with the "speed test".

The frames are preset for the installation of the calibration system and platforms for two-wheel motor vehicles.

UNISYSTEM FlatBOX - Flat S



QUADRO ELETTRICO

Il quadro elettrico di comando e gestione del “prova freni”, compatto ed espandibile, è completo di un’unità di elaborazione dati e un’unità di azionamento motoriduttori. È utilizzabile in abbinamento al cabinato oppure in configurazione “dir”.

ELECTRIC PANEL

The electric control panel to control and manage the “brake test” is compact and expandable, and is complete with a data processing unit and a gear motor driving unit. It can be used in combination with the cabinet or in “dir” configuration.



1

Predisposizione montaggio ventola di raffreddamento (in abbinamento ad inverter).
Ready for the installation of a cooling fan (in combination with inverter).



2

Interruttore sezionatore lucchettabile.
Padlockable disconnect switch.



3

Fungo di emergenza.
Emergency mushroom-head button.

MODULARITÀ / MODULARITY

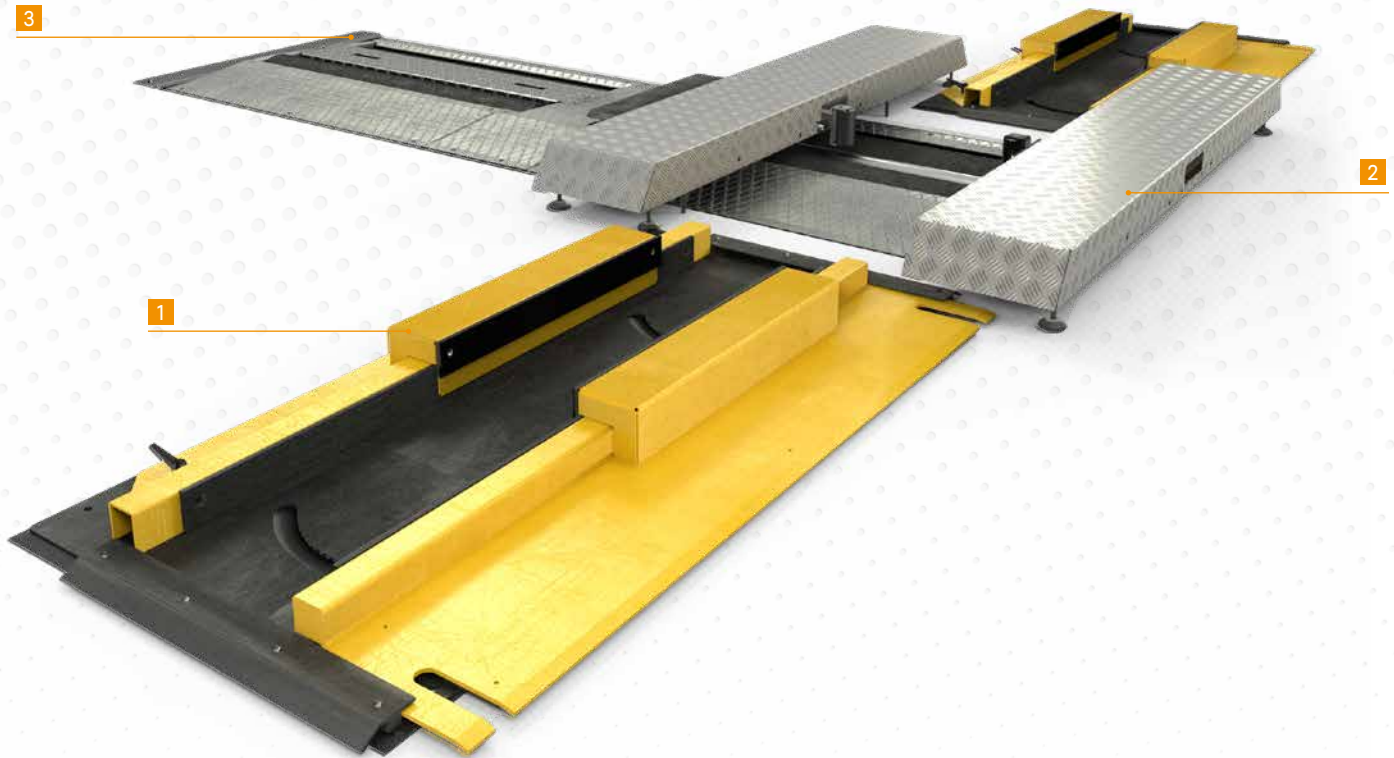

CONFIGURAZIONE PER MOTOVEICOLI A 2, 3 E 4 RUOTE

Una serie di accessori consente a Unisystem FlatBOX e Unisystem Flat S una verifica agevole e sicura di tutti i motoveicoli.

Nel caso dei 2 ruote prevede l'adozione anche di morsa pneumatiche ribassate gestibili dal programma operativo. I marciapiedi amovibili completano la dotazione di prova.

CONFIGURATION FOR 2-, 3- AND 4-WHEEL MOTOR VEHICLES

A series of accessories allows the Unisystem FlatBOX and the Unisystem Flat S to be easily and safely checked on all motor vehicles.

For 2-wheel vehicles, it is also possible to use lowered pneumatic clamps that can be managed from the operating program.

The removable platforms complete the testing equipment.



Morsa pneumatica asimmetrica ribassata.
Lowered asymmetrical pneumatic clamp.

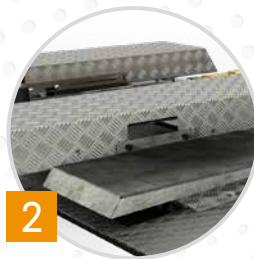

Marciapiedi amovibili.
Removable platforms.



Copertura "Fast drive" per semibancata non in uso.
"Fast drive" cover for half bank not being used.

UNISYSTEM FlatBOX - Flat S



NUOVO SOFTWARE A ICONE

Il nuovo software, completamente rinnovato, offre una modalità di navigazione chiara, facile e veloce.

Semplici icone indicano all'operatore la funzione di misura desiderata, e un'interfaccia intuitiva lo guiderà durante tutte le fasi di misurazione.

L'abbinamento al monitor touch screen (opzionale) incrementa il concetto di accesso diretto alla misurazione.

NEW ICON-BASED SOFTWARE

The new, completely renewed software, provides a clear, easy and quick browsing mode.

Clear icons show the desired measuring function to the operator, and an intuitive interface guides him or her during all measurement steps.

Its combination with the touch screen monitor (optional) enhances the direct measurement access concept.



Caricamento facile e veloce del veicolo accettato/prenotato in contesto pc apparecchiatura (MCTC NET 2).
Easy and quick loading of the accepted/reserved vehicle in equipment PC context (MCTC NET 2).

Accesso diretto ed immediato alla funzione di misura desiderata.
Direct and immediate access to the desired measurement function.



Icone chiare ed intuitive.
Clear and intuitive icons.



TELECOMANDO

Nuovo telecomando multifunzionale per una navigazione facile e veloce.
 Navigazione multidirezionale per una selezione immediata della funzione operativa.

REMOTE CONTROL

New multifunction remote control for easy and quick browsing.

Multi-directional browsing for immediate selection of the operating function.



Navigazione multidirezionale.
Multi-directional browsing.

Misurazione a distanza dello sforzo all'organo di comando.
Remote measurement of control component force.

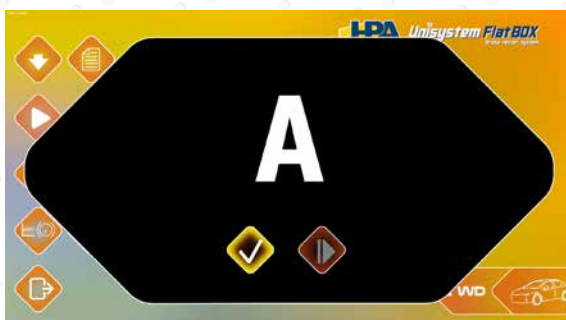

Navigazione contestuale al software operativo.
Browsing in conjunction with the operating software.

UNISYSTEM FlatBOX



CABINATI DI MISURA

Tra gli accessori è possibile scegliere quale tipo di unità centrale impiegare in configurazione pc apparecchiatura (MCTC NET 2).

La versione compatta LCT ADV riunisce in una elegante struttura tutti gli elementi necessari alla gestione del "prova freni".

La stampante trova posto su di un pratico supporto carrellato.

Il controllo della bancata avviene attraverso il quadro elettrico esterno.

MEASURING CABINETS

The accessories available allow to choose the type of central unit to be used in equipment PC configuration (MCTC NET 2). The compact LCT ADV version combines all the elements required for "brake test" in an elegant structure. The printer is located on a convenient trolley stand.

The bank is controlled through the external electric panel.

UNISYSTEM Flat S



CONFIGURAZIONE CON CABINATO MCTC

Il cabinato MCTC offre una soluzione che, oltre ad ospitare tutti gli elementi necessari alla gestione del “prova freni”, incorpora al suo interno il quadro elettrico di gestione della bancata e un alloggio per la stampante A4.

Il monitor da 26” garantisce una visione chiara e nitida anche a distanza.

CONFIGURATION WITH MCTC CABINET

The MCTC cabinet offers a solution that, in addition to housing all the elements necessary for managing the “brake test”, incorporates the electric panel for managing the bank and a housing for the A4 printer.

A 26” monitor ensures a clear and neat view even from a distance.

ACCESSORI / ACCESSORIES
UNISYSTEM Flat BOX

BANCO PROVA FRENI A RULLI PER VEICOLI LEGGERI E 2-3-4 RUOTE - FLAT VERSION - UNISYSTEM - FLATBOX
ROLLER BRAKE TEST BENCH FOR LIGHT-DUTY AND 2, 3, 4-WHEEL VEHICLES - FLAT VERSION - UNISYSTEM - FLATBOX



● **GRUPPO RULLI ADV FLAT**
ADV FLAT ROLLER UNIT

ACCESSORI OBBLIGATORI, CONFIGURAZIONE AUTO (configurazione minima obbligatoria per il funzionamento del banco)
MANDATORY ACCESSORIES, CAR CONFIGURATION (minimum mandatory configuration for bench operation)



● **QUADRO ELETTRICO BOX FLAT**
BOX FLAT ELECTRIC PANEL



● **CORNICE SINGOLA PER INCASSO ADV**
SINGLE FRAME FOR ADV RECESSED INSTALLATION



● **KIT TELECOMANDO RADIO CT ADV**
CT ADV RADIO REMOTE CONTROL KIT

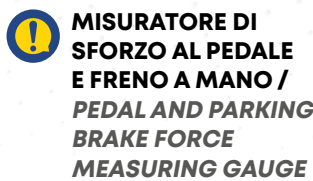

● **MISURATORE DI SFORZO AL PEDALE E FRENO A MANO / PEDAL AND PARKING BRAKE FORCE MEASURING GAUGE**



● **KIT PERSONALIZZAZIONE UNISYSTEM FLAT BOX AUTO**
CUSTOMISATION KIT UNISYSTEM FLAT BOX AUTO

OPZIONE MOTOVEICOLI A 2 RUOTE / OPTION FOR 2-WHEEL MOTOR VEHICLES

KIT PERSONALIZZAZIONE UNISYSTEM FLAT BOX MOTO
CUSTOMISATION KIT UNISYSTEM FLAT BOX MOTO



COPERTURA CARRABILE PER ADV (1 pezzo)
VEHICLE-ACCESSIBLE COVER FOR ADV (1 piece)



COPPIA DINAMOMETRI MOTO
PAIR OF DYNAMOMETERS FOR MOTORCYCLES



KIT FISSAGGIO DI SICUREZZA VEICOLO (IN ALTERNATIVA ALLE MORSE PNEUMATICHE)
VEHICLE SAFETY FASTENING KIT (ALTERNATIVE TO PNEUMATIC CLAMPS)



KIT MARCIAPIEDI PER ADV
PLATFORM KIT FOR ADV



KIT CALIBRAZIONE COMPLETO
COMPLETE CALIBRATION KIT

OPZIONE VEICOLI 3/4 RUOTE / OPTION FOR 3/4-WHEEL VEHICLES

KIT PERSONALIZZAZIONE UNISYSTEM FLAT BOX 3/4 RUOTE
CUSTOMISATION KIT UNISYSTEM FLAT BOX 3/4 WHEELS



COPPIA DINAMOMETRI MOTO
PAIR OF DYNAMOMETERS FOR MOTORCYCLES



KIT COMPLETAMENTO 3/4 RUOTE
3/4 WHEELS COMPLETION KIT



KIT CALIBRAZIONE COMPLETO
COMPLETE CALIBRATION KIT



COPERTURA CARRABILE PER ADV (1 pezzo)
VEHICLE-ACCESSIBLE COVER FOR ADV (1 piece)

ACCESSORI ADDIZIONALI / ADDITIONAL ACCESSORIES



● **CABINATO UNIVERSALE LCT ADV RAL 2004 BUCCIATO**
UNIVERSAL LCT ADV CABINET, RAL 2004 TEXTURED FINISH



PC APPARECCHIATURA (WIN 10)
EQUIPMENT PC (WIN 10)



MONITOR A COLORI LCD 19" WIDESCREEN
19" WIDE SCREEN LCD COLOUR MONITOR



MONITOR TOUCH SCREEN 22"
22" TOUCH SCREEN MONITOR



KIT SUPPORTO FISSO MONITOR LCD
LCD MONITOR FIXED SUPPORT KIT



KIT STAMPANTE A COLORI A4 A GETTO DI INCHIOSTRO
INKJET COLOUR A4 PRINTER KIT



CABINATO VIDEOSYSTEM CONTROLLI VISIVI
VISUAL CHECK VIDEOSYSTEM CABINET



KIT PERSONALIZZAZIONE PER CABINATO LCT ADV MF
CUSTOMISATION KIT FOR LCT ADV MF CABINET



MOBILETTO PER STAMPANTE
PRINTER SUPPORT



COPERTURA CARRABILE PER ADV (1 pezzo)
VEHICLE-ACCESSIBLE COVER FOR ADV (1 piece)



CORNICE DI MONTAGGIO IN FOSSA UNICA PER ADV (con prova velocità)
MOUNTING FRAME IN UNIQUE PIT FOR ADV (with speed test)



KIT MARCIAPIEDI PER ADV PER INSTALLAZIONE IN FOSSA UNICA
PLATFORM KIT FOR ADV FOR INSTALLATION IN UNIQUE PIT



COPPIA DI MORSE PNEUMATICHE ASIMMETRICHE RIBASSATE DA INCASSO
(in alternativa al Kit fissaggio di sicurezza)
PAIR OF LOWERED ASYMMETRICAL PNEUMATIC CLAMPS FOR RECESSED INSTALLATION
(alternative to safety fastening kit)



CORNICE DA INCASSO PER MORSA PNEUMATICA ASIMMETRICA (1 pezzo)
RECESSED FRAME FOR ASYMMETRICAL PNEUMATIC CLAMP (1 piece)



OPZIONE MORSE PNEUMATICHE PER QE (da installare in abbinamento alle morse pneumatiche)
OPTION, PNEUMATIC CLAMPS FOR EP (to be installed in combination with the pneumatic clamps)



Accessori obbligatori.
Compulsory accessories.



Accessori obbligatori nel caso di opzione MOTOVEICOLI A 2 RUOTE e/o VEICOLI 3/4 RUOTE. Nel caso venissero installate entrambe le opzioni è necessario acquistare un solo elemento contrassegnato che verrà utilizzato sia per l'opzione MOTOVEICOLI A 2 RUOTE che per VEICOLI 3/4 RUOTE.



Accessori opzionali.
Optional accessories.

Compulsory accessories in case of 2-WHEEL VEHICLES and/or 3/4-WHEEL VEHICLES option. If both options are installed, it is necessary to purchase only one marked element, that will be used both for 2-WHEEL and 3/4-WHEEL VEHICLES options.

BANCO PROVA FRENI A RULLI PER VEICOLI LEGGERI E 2-3-4 RUOTE - UNISYSTEM - FLAT S
ROLLER BRAKE TEST BENCH FOR LIGHT-DUTY AND 2-, 3-, 4-WHEEL VEHICLES - FLAT VERSION



● **GRUPPO RULLI ADV FLAT**
ADV FLAT ROLLER UNIT

ACCESSORI OBBLIGATORI, CONFIGURAZIONE AUTO (configurazione minima obbligatoria per il funzionamento del banco)
MANDATORY ACCESSORIES, CAR CONFIGURATION (minimum mandatory configuration for bench operation)

! **QUADRO ELETTRICO FLAT S**
FLAT S ELECTRIC PANEL



● **CORNICE SINGOLA PER INCASSO ADV**
SINGLE FRAME FOR ADV RECESSED INSTALLATION



● **KIT TELECOMANDO RADIO CT ADV**
CT ADV RADIO REMOTE CONTROL KIT



● **CABINATO VIDEOSYSTEM ADV**
ADV VIDEOSYSTEM CABINET

! **MISURATORE DI SFORZO AL PEDALE E FRENO A MANO**
PEDAL AND PARKING BRAKE FORCE MEASURING GAUGE

! **PC APPARECCHIATURA (WIN 10)**
EQUIPMENT PC (WIN 10)

! **KIT PERSONALIZZAZIONE UNISYSTEM FLAT S AUTO**
CUSTOMISATION KIT UNISYSTEM FLAT S AUTO

OPZIONE MOTOVEICOLI A 2 RUOTE / OPTION FOR 2-WHEEL MOTOR VEHICLES

! **KIT PERSONALIZZAZIONE UNISYSTEM FLAT BOX MOTO**
CUSTOMISATION KIT UNISYSTEM FLAT BOX MOTO

! **COPERTURA CARRABILE PER ADV (1 pezzo)**
VEHICLE-ACCESSIBLE COVER FOR ADV (1 piece)

! **COPPIA DINAMOMETRI MOTO**
PAIR OF DYNAMOMETERS FOR MOTORCYCLES

! **KIT FISSAGGIO DI SICUREZZA VEICOLO (IN ALTERNATIVA ALLE MORSE PNEUMATICHE)**
VEHICLE SAFETY FASTENING KIT (ALTERNATIVE TO PNEUMATIC CLAMPS)

! **KIT MARCIAPIEDI PER ADV**
PLATFORM KIT FOR ADV

! **KIT CALIBRAZIONE COMPLETO**
COMPLETE CALIBRATION KIT

OPZIONE VEICOLI 3/4 RUOTE / OPTION FOR 3/4-WHEEL VEHICLES

- 

KIT PERSONALIZZAZIONE UNISYSTEM FLAT S 3/4 RUOTE
CUSTOMISATION KIT UNISYSTEM FLAT S 3/4 WHEELS
- 

KIT COMPLETAMENTO 3/4 RUOTE
3/4 WHEELS COMPLETION KIT
- 

COPPIA DINAMOMETRI MOTO
PAIR OF DYNAMOMETERS FOR MOTORCYCLES
- 

COPERTURA CARRABILE PER ADV (1 pezzo)
VEHICLE-ACCESSIBLE COVER FOR ADV (1 piece)
- 

KIT CALIBRAZIONE COMPLETO
COMPLETE CALIBRATION KIT

ACCESSORI ADDIZIONALI / ADDITIONAL ACCESSORIES

- 

KIT STAMPANTE A COLORI A4 A GETTO DI INCHIOSTRO
INKJET COLOUR A4 PRINTER KIT
- 

COPERTURA CARRABILE PER ADV (1 pezzo)
VEHICLE-ACCESSIBLE COVER FOR ADV (1 piece)
- 

CORNICE DI MONTAGGIO IN FOSSA UNICA PER ADV (con prova velocità)
MOUNTING FRAME IN UNIQUE PIT FOR ADV (with speed test)
- 

KIT MARCIAPIEDI PER ADV PER INSTALLAZIONE IN FOSSA UNICA
PLATFORM KIT FOR ADV FOR INSTALLATION IN UNIQUE PIT
- 

COPPIA DI MORSE PNEUMATICHE ASIMMETRICHE RIBASSATE DA INCASSO
(in alternativa al Kit fissaggio di sicurezza)
PAIR OF LOWERED ASYMMETRICAL PNEUMATIC CLAMPS FOR RECESSED INSTALLATION
(alternative to safety fastening kit)
- 

CORNICE DA INCASSO PER MORSA PNEUMATICA ASIMMETRICA (1 pezzo)
RECESSED FRAME FOR ASYMMETRICAL PNEUMATIC CLAMP (1 piece)
- 

OPZIONE MORSE PNEUMATICHE PER QE (da installare in abbinamento alle morse pneumatiche)
OPTION, PNEUMATIC CLAMPS FOR EP (to be installed in combination with the pneumatic clamps)

 Accessori obbligatori.
Compulsory accessories.

 Accessori opzionali.
Optional accessories.

 Accessori obbligatori nel caso di opzione MOTOVEICOLI A 2 RUOTE e/o VEICOLI 3/4 RUOTE. Nel caso venissero installate entrambe le opzioni è necessario acquistare un solo elemento contrassegnato che verrà utilizzato sia per l'opzione MOTOVEICOLI A 2 RUOTE che per VEICOLI 3/4 RUOTE.

Compulsory accessories in case of 2-WHEEL VEHICLES and/or 3/4-WHEEL VEHICLES option. If both options are installed, it is necessary to purchase only one marked element, that will be used both for 2-WHEEL and 3/4-WHEEL VEHICLES options.

DATI TECNICI-SPECIFICHE TECNICHE / TECHNICAL DATA-TECHNICAL SPECIFICATIONS

Bancata rulli per utilizzo su veicoli leggeri (≤ 3,5 t) Roller bank for use on light-duty vehicles (≤ 3.5 t)	Dato / Value
Dimensioni (mm) / Dimensions (mm)	888 x 2.520 x 310
Peso (Kg) / Weight (Kg)	700
Telaio / Frame	Verniciato con polveri epossidiche anticorrosive. Ricoperture passaggi ruota zincati. Painted with anti-corrosion epoxy powders. Galvanised wheel passage covers.
Lunghezza utile dei rulli (mm) / Roller useful length (mm)	1.100
Distanza interna rulli (mm) / Roller internal distance (mm)	240
Distanza esterna rulli (mm) / Roller external distance (mm)	2.440
Carico ammissibile per asse al passaggio (N) Permitted load per axle upon passage (N)	30.000
Carico ammissibile in prova per asse (N) Permitted load per axle during testing (N)	20.000
Diametro rulli (mm) / Roller diameter (mm)	202
Interasse rulli (mm) / Roller centre distance (mm)	370
Velocità periferica rulli a vuoto (km/h) Zero-load roller peripheral speed (km/h)	5,3
Disassamento verticale (mm) / Vertical set back (mm)	45
Coefficiente di aderenza / Coefficient of adhesion	≥ 0,7 anche a rulli bagnati ≥ 0.7 even with wet rollers
Potenza motori (kW) / Motor power (kW)	4
Sistema di uscita veicolo dai rulli / Vehicle exit from rollers system	Avviamento dei rulli / Freno sul motore elettrico Roller start-up / Brake on electric motor

Caratteristiche per impiego specifico su motoveicoli 2 e 3/4 ruote Features for specific use on 2-wheel and 3/4-wheel motor vehicles	Dato / Dato
Lunghezza utile dei rulli (mm) A MEZZO DI KIT SPECIFICO per soli veicoli a 2 ruote Roller useful length (mm) THROUGH SPECIFIC KIT for 2-wheel vehicles only	400
Carico ammissibile in prova per asse (N) / Permitted load per axle during testing (N)	5.000

Sistema di bloccaggio ruota per motoveicoli a due ruote / Wheel clamping system for two-wheel motor vehicles	
Morse pneumatiche / Pneumatic clamps	Morse pneumatiche ribassate gestite dal programma operativo Lowered pneumatic clamps managed by the operating program
Sistema a cinghie / Belt system	Fissaggio manuale a cinghia della ruota non in prova Manual belt fastening of the wheel not being tested

Caratteristiche elettriche / Electrical features	
Alimentazione / Power supply	400 V / 3 Ph / 50 Hz
Potenza nominale / Rated power	2 x 4 Kw
Potenza massima assorbita / Maximum absorbed power	18 Kw

Compatibilità MCTCNET2 / MCTCNET2 compatibility	
UNISYSTEM FLAT BOX	DIR / RETE
UNISYSTEM FLAT S	RETE

DATI TECNICI-SPECIFICHE TECNICHE / TECHNICAL DATA-TECHNICAL SPECIFICATIONS

Caratteristiche metrologiche per utilizzo su veicoli leggeri ($\leq 3,5$ t) <i>Metrological features for use on light-duty vehicles (≤ 3.5 t)</i>	Udm / Udm	Caratteristiche - precisione <i>Features - precision</i>
Fondo scala di misura della forza frenante (singola ruota) <i>Braking force measurement full scale (single wheel)</i>	N	6.000
Fondo scala di misura dispositivo pesatura (asse) <i>Weighing device measurement full scale (axle)</i>	N	25.000
Fondo scala di misura dello sforzo al comando pedale <i>Measurement full scale of pedal control force</i>	N	800
Fondo scala di misura dello sforzo al comando freno di stazionamento <i>Measurement full scale of clamping brake control force</i>	N	800
Precisione di misura per sforzo frenante (limite errore globale fra 0 e 40° C) <i>Measurement precision for braking effort (global error limit between 0 and 40°C)</i>	%	± 50 N sino a 3.500 N; $\pm 1,6\%$ valore misurato sino a 6.000N ± 50 N up to 3,500 N; $\pm 1.6\%$ measured value up to 6,000N
Precisione di misura per forza peso (limite errore globale fra 0 e 40° C) <i>Measurement precision for weight force (global error limit between 0 and 40°C)</i>	%	$\leq 2\%$ per valori fino a 10.000 N $\leq 2\%$ for values up to 10,000 N
Precisione di misura per sforzo al comando Manuale /Pedale (limite errore globale fra 0 e 40° C) <i>Measurement precision for Manual control/Pedal force (global error limit between 0 and 40°C)</i>	%	$\leq 1\%$ FS per valori fino a 500 N $\leq 1\%$ FS for values up to 500 N
Taratura dello zero / Automatic zero		automatica, prima dell'avvio test <i>calibration before test start</i>
Misurazione delle forze / Force measurement	/	basata su celle di carico estensimetriche <i>based on strain gauge load cells</i>
Risoluzione dissimmetria di frenatura / Braking dyssimmetry resolution	%	≤ 1
Misura del peso / Weight measurement		misurazione del peso asse attraverso il sistema di pesatura installato sotto la bancata <i>axle weight measurement through the weighing system installed under the bank</i>

Caratteristiche metrologiche per utilizzo per utilizzo su motoveicoli a 2 ruote, tricicli quadricicli leggeri <i>Metrological features for use on 2-wheel motor vehicles, light-duty three-wheel and four-wheel vehicles</i>	Udm / Udm	Caratteristiche - precisione <i>Features - precision</i>
Fondo scala di misura della forza frenante (singola ruota) <i>Braking force measurement full scale (single wheel)</i>	N	3.000
Fondo scala di misura dispositivo pesatura (asse) <i>Weighing device measurement full scale (axle)</i>	N	5.000
Fondo scala di misura dello sforzo al comando pedale <i>Measurement full scale of pedal control force</i>	N	300
Fondo scala di misura dello sforzo al comando freno di stazionamento <i>Measurement full scale of clamping brake control force</i>	N	500
Precisione di misura per sforzo frenante (limite errore globale fra 0 e 40° C) <i>Measurement precision for braking effort (global error limit between 0 and 40°C)</i>	%	± 20 N sino a 1.000 N; $\pm 2\%$ valore misurato sino a 3.000 N ± 20 N up to 1,000 N; $\pm 2\%$ measured value up to 3,000 N
Precisione di misura per forza peso (limite errore globale fra 0 e 40° C) <i>Measurement precision for weight force (global error limit between 0 and 40°C)</i>	%	± 20 N sino a 1.000 N; $\pm 2\%$ valore misurato sino a 5.000 N ± 20 N up to 1,000 N; $\pm 2\%$ measured value up to 5,000 N



NEXION S.p.A.
info@hpa-faip.it
www.hpa-faip.it

