



**IN VIGORE DA  
GENNAIO 2024**

**CATALOGO ITALIA  
SMONTAGOMME  
VEICOLI LEGGERI & PESANTI  
E ACCESSORI ORIGINALI**

**ED. MAGGIO 2024**

# TABELLA COLORI

- 1) Il colore standard delle ns. attrezzature è il blu RAL 5015 ( L /25).
- 2) A richiesta è possibile avere le attrezzature con colori diversi (vedi tabella colori RAL) \*.

• Di seguito la tabella per colori:

	→ /25 RAL 5015 Blu cielo
	→ /A4 RAL 5011 Blu (Peugeot)
	→ /22 RAL 5011 Blu (Peugeot) bucciato
	→ /16 RAL 3002 Rosso
	→ /45 RAL 1003 Giallo (Renault)
	→ /38 RAL 7042 Grigio (Renault)
	→ /39 RAL 7040 Grigio finestra (Volkswagen / Porsche / Fiat)
	→ /33 RAL 7011 Grigio (Mercedes)
	→ /65 RAL 7012 Grigio (Mercedes)
	→ /52 RAL 7015 Grigio (Mercedes)
	→ /69 RAL 7030 Grigio pietra (Ferrari / Maserati)
	→ /34 RAL 7016 Grigio antracite (BMW)

• Colorazioni differenti subordinate a conferma dell'Ufficio Commerciale.

\*: L'attrezzatura in colore diverso da quello standard può essere soggetta ad eventuale sovrapprezzo.

Le immagini contenute nel presente stampato hanno il solo scopo di presentare il prodotto e pertanto non sono vincolanti. La ditta si riserva il diritto di apportare, in qualsiasi momento e senza preavviso, le modifiche che ritenesse utili.

La NEXION S.p.A. declina ogni responsabilità in caso di reclami derivanti dall'uso di accessori o ricambi non originali con conseguente decadenza della dichiarazione CE di conformità..

## SMONTAGOMME UNIVERSALI "LEVER-LESS"

M 1032	
M 1032	
M 1028	
M 928 ROYAL	
M 830 LL	
M 830 M	
ACCESSORI A RICHIESTA PER SMONTAGOMME UNIVERSALI "LEVER-LESS"	

## SMONTAGOMME TRADIZIONALI "LEVER-LESS"

M 824 LL	
ACCESSORI A RICHIESTA PER M 824 LL	

## SMONTAGOMME TRADIZIONALI

M 724S	
M 624	
M 522	
M 424 A	
M 424	
M 422	
ACCESSORI A RICHIESTA PER SMONTAGOMME LEGGERI (TUTTI)	
ACCESSORI A RICHIESTA PER SMONTAGOMME LEGGERI TRADIZIONALI	

## SMONTAGOMME LEGGERI MOTO

M 322 BIKE	
ACCESSORI A RICHIESTA PER M 322 BIKE	
M 200 BIKE	
ACCESSORI A RICHIESTA PER M 200 BIKE	

<b>4</b>	<b>SMONTAGOMME PESANTI</b>	<b>45</b>
4	F 565	45
5	F 562	46
7	F 562 M	47
8	F 560 - F 560 A SPECIAL	48
9	F 560 - F 560 A SPECIAL Y	49
10	F 560 A	50
11	F 560	51
	F 260	52
	F 240 A	53
<b>21</b>	F 230 MOBILE	<b>54</b>
21	F 226 MOBILE	55
22	ACCESSORI A RICHIESTA PER SMONTAGOMME PESANTI	56
<b>24</b>	TABELLA PESI DIMENSIONI IMBALLI MACCHINE	<b>63</b>
24	CONDIZIONI GENERALI DI VENDITA	65
25		
26		
27		
28		
29		
30		
32		
<b>39</b>		
39		
40		
42		
43		



# SMONTAGOMME UNIVERSALI "LEVER-LESS"

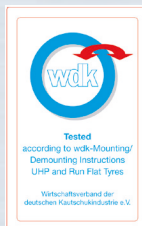

**LEVER-LESS & Contact-Less**  
Technologies

**HYDRAULIC Power**

Ciclo di smontaggio  
**AUTOMATICO**



M 1032 DIAMOND A

## M 1032 P.L. serie

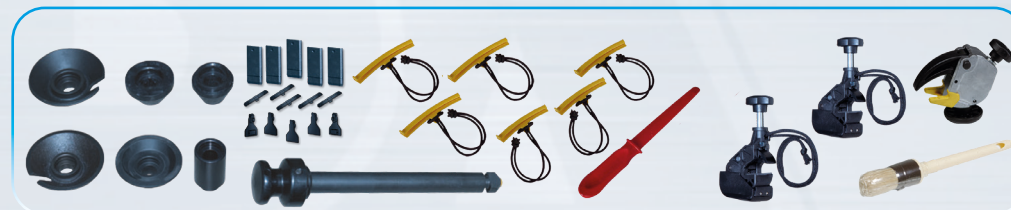

- Tutti i modelli completi di:
- 1 Maniglia di bloccaggio ruota completa
  - 1 Serie di coni di centraggio ruota
  - 3 Protezioni bordo cerchio
  - 3 Protezioni bordo cerchio corte
  - 2 Leva in plastica di protezione tallone
  - 1 Kit di inserti plastici per torretta (Revolver)
  - 1 Pennello per lubrificante talloni
  - 2 Pinze PPT premitalloni/antislittamento
  - 1 Morsetto basculante
  - 1 Manuali istruzioni

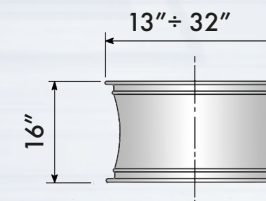

**M 1032**

Codice	Alimentazione	Descrizione
0-11201310/25	200-230V/1Ph/50Hz	<b>M 1032 STD A P.L.</b> - Con ciclo AUTOMATICO di stallonatura e smontaggio.
0-11201306/25	200-230V/1Ph/50Hz	<b>M 1032 SILVER P.L.</b>
0-11201311/25	200-230V/1Ph/50Hz	<b>M 1032 SILVER A P.L.</b> - Con ciclo AUTOMATICO di stallonatura e smontaggio.
0-11201307/25	200-230V/1Ph/50Hz	<b>M 1032 GOLD P.L.</b>
0-11201308/25	200-230V/1Ph/50Hz	<b>M 1032 DIAMOND A</b> - Con ciclo AUTOMATICO di stallonatura e smontaggio.



: Particolare NUOVO o MODIFICATO



# SMONTAGOMME UNIVERSALI "LEVER-LESS"

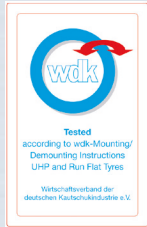

**LEVER-LESS & Contact-Less**  
Technologies

**HYDRAULIC Power**



## M 1032 S.L. serie



- Tutti i modelli completi di:
- 1 Maniglia di bloccaggio ruota completa
  - 1 Serie di coni di centraggio ruota
  - 3 Protezioni bordo cerchio
  - 3 Protezioni bordo cerchio corte
  - 2 Leva in plastica di protezione tallone
  - 1 Kit di inserti plastici per torretta (Revolver)
  - 1 Pennello per lubrificante talloni
  - 2 Pinze PPT premitalloni/antislittamento
  - 1 Morsetto basculante
  - 1 Manuali istruzioni

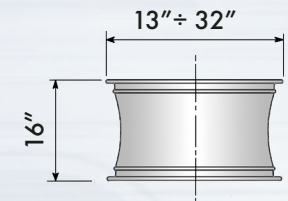

### M 1032

Codice	Alimentazione	Descrizione
0-11201301/25	200-230V/1Ph/50Hz	<b>M 1032 STD</b>
0-11201302/25	200-230V/1Ph/50Hz	<b>M 1032 SILVER S.L.</b>
0-11201304/25	200-230V/1Ph/50Hz	<b>M 1032 GOLD S.L.</b>



: Particolare NUOVO o MODIFICATO

# SMONTAGOMME UNIVERSALI "LEVER-LESS"

## M 1032 serie RIASSUNTO CARATTERISTICHE



7. Ciclo AUTOMATICO di smontaggio (vedi tabella)

### □ Versioni disponibili

M 1032 Modello	STD	STD A P.L.	SILVER S.L.	SILVER P.L.	SILVER A P.L.	GOLD S.L.	GOLD P.L.	DIAMOND A
1. Sollevatore ruota laterale	<input checked="" type="checkbox"/>		<input checked="" type="checkbox"/>			<input checked="" type="checkbox"/>		
2. Premitalлоне	<input checked="" type="checkbox"/>	<input checked="" type="checkbox"/>	<input checked="" type="checkbox"/>	<input checked="" type="checkbox"/>	<input checked="" type="checkbox"/>	<input checked="" type="checkbox"/>	<input checked="" type="checkbox"/>	<input checked="" type="checkbox"/>
3. Telecamera			<input checked="" type="checkbox"/>	<input checked="" type="checkbox"/>	<input checked="" type="checkbox"/>	<input checked="" type="checkbox"/>	<input checked="" type="checkbox"/>	<input checked="" type="checkbox"/>
4. Gonfiatore elettronico						<input checked="" type="checkbox"/>	<input checked="" type="checkbox"/>	<input checked="" type="checkbox"/>
5. TPM-02 Reader								<input checked="" type="checkbox"/>
6. Sollevatore ruota frontale		<input checked="" type="checkbox"/>		<input checked="" type="checkbox"/>	<input checked="" type="checkbox"/>		<input checked="" type="checkbox"/>	<input checked="" type="checkbox"/>
7. Ciclo automatico		<input checked="" type="checkbox"/>			<input checked="" type="checkbox"/>			<input checked="" type="checkbox"/>

: Di serie



# SMONTAGOMME UNIVERSALI "LEVER-LESS"

## M 1028

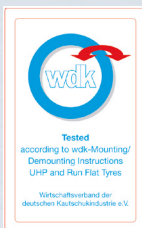

**LEVER-LESS & Contact-Less**  
Technologies



- Tutti i modelli completi di:
- 1 Maniglia di bloccaggio ruota completa
  - 1 Serie di coni di centraggio ruota
  - 3 Protezioni bordo cerchio
  - 3 Protezioni bordo cerchio corte
  - 2 Leva in plastica di protezione tallone
  - 1 Pennello per lubrificante talloni
  - 1 Manuali istruzioni
  - 1 Supporto vaso porta grasso
  - 1 Set protezioni utensile montaggio/smontaggio



**M 1028**

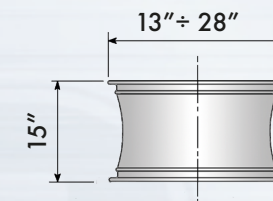

Codice	Alimentazione	Descrizione
0-11212012/25	200 - 230V/1Ph/50Hz	<b>M 1028 2V IP</b> con premi tallone
0-11212032/25	200 - 230V/1Ph/50Hz	<b>M 1028 2V IP</b> con premi tallone e sollevatore
0-11212042/25	200 - 230V/1Ph/50Hz	<b>M 1028 2V IP FS</b> con premi tallone e sollevatore



: Particolare NUOVO o MODIFICATO



# SMONTAGOMME UNIVERSALI "LEVER-LESS"



## M 928 *Royal*

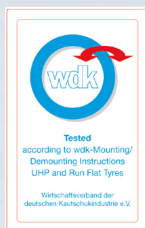

- Tutti i modelli completi di:
- 1 Maniglia di bloccaggio ruota completa
  - 1 Serie di coni di centraggio ruota
  - 3 Protezioni bordo cerchio
  - 3 Protezioni bordo cerchio corte
  - 2 Leva in plastica di protezione tallone
  - 1 Kit di inserti plastici per torretta
  - 1 Pennello per lubrificante talloni
  - 2 Pinze PPT premitalloni/antislittamento
  - 1 Manuali istruzioni



## M 928 ROYAL

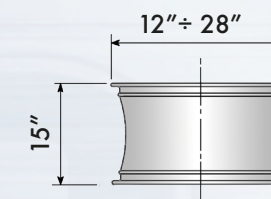

Codice	Alimentazione	Descrizione
0-11106752/25	230V/1Ph/50-60Hz	<b>M 928 Royal + KWL 28</b> Sollevatore ruota - Sistema "IP" (Increased Power System)
0-11106762/25	230V/1Ph/50-60Hz	<b>M 928 Royal senza KWL28</b> - Sistema "IP" (Increased Power System)



: Particolare NUOVO o MODIFICATO

# SMONTAGOMME UNIVERSALI "LEVER-LESS"



## M 830 LL



- Tutti i modelli completi di:
- 1 Maniglia di bloccaggio ruota completa
  - 1 Serie di coni di centraggio ruota
  - 3 Protezioni bordo cerchio
  - 3 Protezioni bordo cerchio corte
  - 2 Leva in plastica di protezione tallone
  - 1 Kit di inserti plastici per torretta
  - 1 Pennello per lubrificante talloni
  - 2 Pinze PPT premitalloni/antislittamento
  - 1 Manuali istruzioni

## M 830 LL

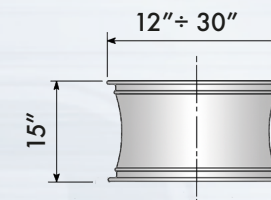

Codice	Alimentazione	Descrizione
0-15200112/25	230V/1Ph/50-60Hz	<b>M 830 LL + KFS 30 + KWL 30</b> - Sistema "IP" (Increased Power System).
0-15200132/25	230V/1Ph/50-60Hz	<b>M 830 LL + KWL 30</b> - Sistema "IP" (Increased Power System).
0-15200102/25	230V/1Ph/50-60Hz	<b>M 830 LL</b> - Sistema "IP" (Increased Power System).



: Particolare NUOVO o MODIFICATO



# SMONTAGOMME UNIVERSALI "LEVER-LESS"



## M 830 M

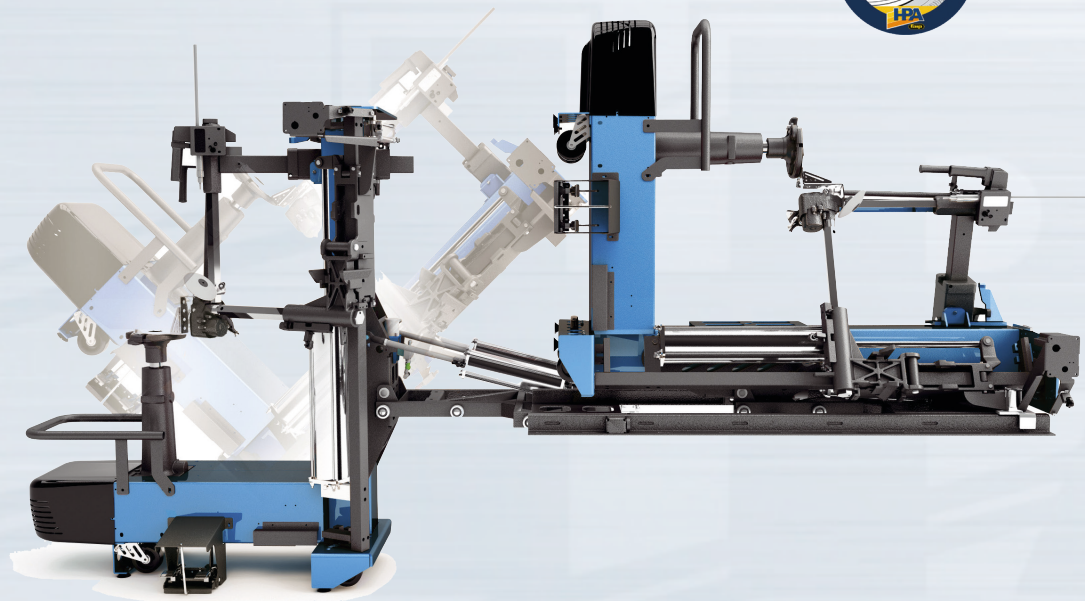

- Tutti i modelli completi di:
- 1 Maniglia di bloccaggio ruota completa
  - 1 Serie di coni di centraggio ruota
  - 3 Protezioni bordo cerchio
  - 3 Protezioni bordo cerchio corte
  - 2 Leva in plastica di protezione tallone
  - 1 Kit di inserti plastici per torretta
  - 1 Pennello per lubrificante talloni
  - 2 Pinze PPT premitalloni/antislittamento
  - 1 Manuali istruzioni

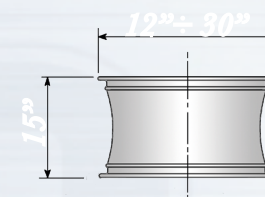

## M 830 M



Codice	Alimentazione	Descrizione
0-15200162/25	230V/1Ph/50-60Hz	<b>M 830 M</b> - SERVIZIO MOBILE (Slitta ribaltabile inclusa)
8-51100038		<b>Kit Power Unit</b> (componentistica completa elettrica e pneumatica per l'allestimento del furgone: pacco batteria 48V, carica batteria, inverter, serbatoio aria, compressore rotativo, cablaggi, etc.).





: Particolare NUOVO o MODIFICATO

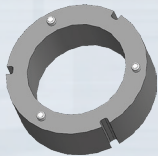



## ACCESSORI A RICHIESTA PER SMONTAGOMME UNIVERSALI "LEVER-LESS"

Codice	Immagine	Descrizione	M 1032	M 1028	M 928 ROYAL	M 830 LL	M 830 M
8-15100026		<b>Distanziale</b> H=64mm per furgoni (Daily)	●				
8-15100027		<b>Dispositivo</b> INDUSTRIA 4.0		●			
8-15100031		<b>Dispositivo</b> INDUSTRIA 4.0			●		
8-15100033		<b>Dispositivo</b> INDUSTRIA 4.0				●	
8-15100012		<b>Dispositivo</b> INDUSTRIA 4.0		●			
8-11100456		<b>MAT TC</b> Porta accessori mobile	●	●	●	●	●

# ACCESSORI A RICHIESTA PER SMONTAGOMME UNIVERSALI "LEVER-LESS"





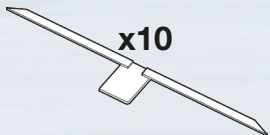

Codice	Immagine	Descrizione	M 1032	M 1028	M 928 ROYAL	M 830 LL	M 830 M
8-11100128		<b>PH 28</b> Premitallone pneumatico			●		
8-11100097		<b>PH 30</b> Premitallone pneumatico				●	
8-11100404		<b>KFS 32</b> Accessorio completo di gonfiaggio per pneumatici tubeless.	●				
8-11120053		<b>Accessorio completo</b> di gonfiaggio rapido		●			

## ACCESSORI A RICHIESTA PER SMONTAGOMME UNIVERSALI "LEVER-LESS"



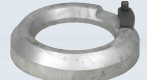

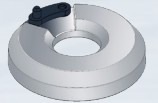
Codice	Immagine	Descrizione	M 1032	M 1028	M 928 ROYAL	M 830 LL	M 830 M
8-11100160		<b>KFS 28</b> Accessorio completo di gonfiaggio per pneumatici tubeless			●		
8-11100111		<b>KFS 30</b> Accessorio completo di gonfiaggio per pneumatici tubeless				●	
8-11100085		<b>KWL 30</b> Dispositivo pneumatico di sollevamento ruota.				●	
8-11100159		<b>SA 28</b> Supporto accessori e attrezzi.			●		
801260235		<b>KRPS 30</b> Kit di 10 reglette per PAX System.				●	●



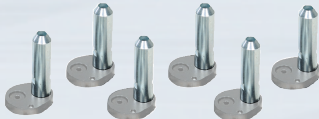

# ACCESSORI A RICHIESTA PER SMONTAGOMME UNIVERSALI "LEVER-LESS"

Codice	Immagine	Descrizione	M 1032	M 1028	M 928 ROYAL	M 830 LL	M 830 M
8-11100287		<b>AUTOLOCK II</b> Maniglia bloccaggio/sbloccaggio cerchi ad azionamento elettrico.			●	●	●
8-11100412		<b>KPBA Kit</b> protezioni bloccaggio automatico.	■				
8-11100400		<b>KPBM Kit</b> protezioni bloccaggio manuale.			■	■	■
8-11100037		<b>Kit</b> per cerchi pick-up e veicoli commerciali leggeri. Diametro foro cerchio: max 158 mm	●	●			
8-11100086		<b>Kit</b> per cerchi pick-up e veicoli commerciali leggeri. Diametro foro cerchio: max 158 mm			●	●	●
8-15100003		<b>Kit</b> adattatore speciale per cerchi alti (H=28mm). Es. ruota posteriore Porsche	●	●			
8-15100040		<b>Kit anello distanziale</b> H 22mm Si abbina con cod. 8-11100037 / 8-11100086 / 8-15100003	●	●	●	●	●

# ACCESSORI A RICHIESTA PER SMONTAGOMME UNIVERSALI "LEVER-LESS"







Codice	Immagine	Descrizione	M 1032	M 1028	M 928 ROYAL	M 830 LL	M 830 M
8-11100039		<b>FCR 28</b> Flangia per ruote a canale rovescio (interasse massimo 183 mm). Colonnette H= 100mm	●	●	●	●	●
8-11100087		<b>FU 28</b> Flangia universale per ruote con cerchi ciechi e speciali.	●		●	●	●
8-11100046		<b>KE 28</b> Kit di estensione per flangia FCR 28 e FU 28. H= 23mm / Diam. 25 mm	●	●	●	●	●
8-11100244		<b>KE 20</b> Kit di 6 colonnette "CORTE" per flangia FCR 28. H= 80mm	●	●	●	●	●
8-11100245		<b>KE 40</b> Kit di 6 colonnette "EXTRA CORTE" per flangia FCR 28. H= 60mm	●	●	●	●	●
8-11100246		<b>KE 25</b> Kit di 6 colonnette "LUNGHE" per flangia FCR 28. H= 125mm	●	●	●	●	●

# ACCESSORI A RICHIESTA PER SMONTAGOMME UNIVERSALI "LEVER-LESS"

Codice	Immagine	Descrizione	M 1032	M 1028	M 928 ROYAL	M 830 LL	M 830 M
8-11100284		<b>KPC 12</b> Kit di 12 cappucci in plastica di protezione.	●	●	●	●	●
8-11100291		<b>KEA 28</b> Kit di 6 colonnette sferiche x nuovi cerchi AUDI x flangia FCR 28.	●	●	●	●	●
8-11100110	 <div style="display: flex; flex-direction: column; align-items: flex-start; margin-top: 10px;"> <div style="display: flex; align-items: center; margin-bottom: 5px;"> <div style="border: 1px solid red; width: 10px; height: 10px; margin-right: 5px;"></div> <span>= Kit per cerchi in lega</span> </div> <div style="display: flex; align-items: center;"> <div style="border: 1px solid blue; width: 10px; height: 10px; margin-right: 5px;"></div> <span>= Kit per cerchi rovesci</span> </div> </div>	<b>FCS 32</b> Kit per ruote NON standard.	●		●	●	●
8-11100038		<b>Flangia universale</b> per cerchi cechi e speciali		●			



## ACCESSORI A RICHIESTA PER SMONTAGOMME UNIVERSALI "LEVER-LESS"

Codice	Immagine	Descrizione	M 1032	M 1028	M 928 ROYAL	M 830 LL	M 830 M
801262417		<b>PPT</b> Pinza premitallone per pneumatici "Run Flat" - Approvato WDK.	■	■	■	■	■
801435685		<b>UPT</b> Utensile premitallone universale.	●	●	●	●	●
8-11100120		<b>Morsetto</b> basculante		●			
8-11120014		<b>REP-3</b> Kit di 3 protezioni bordo cerchio.	■	■	■	■	■
8-11120015		<b>REP-3S</b> Kit di 3 protezioni bordo cerchio corte.	■	■	■	■	■
8-11400293		<b>KPP-LL</b> Kit protezioni in plastica per torretta "LEVER-LESS". Per gli smontagomme fino alla matricola N°: FMG143250			■	■	■

# ACCESSORI A RICHIESTA PER SMONTAGOMME UNIVERSALI "LEVER-LESS"

Codice	Immagine	Descrizione	M 1032	M 1028	M 928 ROYAL	M 830 LL	M 830 M
8-11400325		<b>KPP-LL V3</b> Kit protezioni in plastica per torretta "LEVER-LESS". Per gli smontagomme a partire dalla matricola N°: FMG143251			■	■	■
8-11100401		<b>Kit</b> di protezioni per bloccaggio automatico		■			
8-11120058		<b>Kit</b> di 5 protezioni per coni ø 145 mm		●			
8-11120083		<b>Kit</b> leva retrattile (1 pz. per articolo)	●	●			
8-11120013		<b>PTS</b> Leva in plastica di protezione tallone.	■	■	■	■	■
8-11120035		<b>KPUL</b> Kit protezione utensile in plastica	●	●			
8-11120036		<b>TH</b> Kit protezione utensili	●	●			

# ACCESSORI A RICHIESTA PER SMONTAGOMME UNIVERSALI "LEVER-LESS"



## Dispositivi complementari

Codice	Immagine	Descrizione	M 1032	M 1028	M 928 ROYAL	M 830 LL	M 830 M
8-11100125		DRT Dima regolazione torretta "LEVER-LESS".			●	●	●
6015001300		TPM-02 Strumento di diagnosi sensori TPMS.	●	●	●	●	●
8-64500013		Kit OBD	●	●	●	●	●
6015001391		TPM-02 Plus TPM-02 + kit OBD	●	●	●	●	●
6015001360		TPM-02 Stampante bluetooth.	●	●	●	●	●



## ACCESSORI A RICHIESTA PER SMONTAGOMME UNIVERSALI "LEVER-LESS"

### Dispositivi complementari

Codice	Immagine	Descrizione	M 1032	M 1028	M 928 ROYAL	M 830 LL	M 830 M
8-51100029		<b>TPM-02</b> Abbonamento annuale standard.	●	●	●	●	●
8-51120003		<b>TPM-02</b> Abbonamento annuale esteso.	●	●	●	●	●
8-51120001		<b>TPM-02 + EOBD</b> Abbonamento annuale.	●	●	●	●	●
8-51120004		<b>TPM-02 + EOBD</b> Abbonamento annuale esteso.	●	●	●	●	●
8-51120006		<b>Servizio opzionale</b> di installazione strumento.	●	●	●	●	●

# SMONTAGOMME TRADIZIONALI "LEVER-LESS"



## M 824 LL serie



- Tutti i modelli completi di:
- 1 Guaina per paletta stallonatore
  - 1 Serie di 4 protez. griffe per cerchi in lega
  - 1 Pinza PPT
  - 3 Protezioni bordo cerchio
  - 3 Protezioni bordo cerchio corte
  - 2 Leva plastica di protezione tallone
  - 1 Kit di inserti plastici per torretta
  - 1 Pennello per lubrificante talloni
  - 1 Manuali istruzioni



### M 824 LL

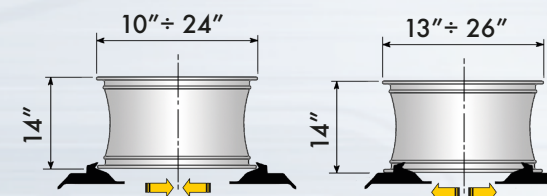

Codice	Alimentazione	Descrizione
0-11110422/25	230V/1Ph/50-60Hz	<b>M 824 2V FS LL + ALLY 90 - Sistema "IP"</b> (Increased Power System).
0-11110402/25	230V/1Ph/50Hz	<b>M 824 FS LL + ALLY 90.</b>
0-11110501/25	400V/3Ph/50Hz	<b>M 824 LL + ALLY 90.</b>
0-11110432/25	230V/1Ph/50-60Hz	<b>M 824 2V FS LL + ALLY 30.</b>











: Particolare NUOVO o MODIFICATO

## ACCESSORI A RICHIESTA PER M 824 LL

Codice	Immagine	Descrizione
8-11100451		<b>ALLY 85</b> Accessorio multifunzione alza/premitallone.
8-11100343		<b>ALLY 30</b> Accessorio univ. alza/premitallone a tre bracci operanti.
8-11120019		<b>ALLY 30 Kit di installazione</b> e personalizzazione per M 824LL - M 724 S.
8-11400058		<b>EFS70/W</b> Gonfiatore elettronico per installazione a muro.
8-11100243		<b>KWL 80</b> Dispositivo pneumatico di sollevamento ruota. Portata: 80 kg.
801262417		<b>PPT</b> Pinza premitallone per pneumatici "Run Flat" - Approvato WDK.
8-11100044		<b>PCL54</b> Serie di 12 protezioni integrali per il bloccaggio dei cerchi in lega.
801258383		<b>GPS60</b> Kit di 6 guaine in plastica per paletta stallonatore.
8-11120014		<b>REP-3</b> Kit di 3 protezioni bordo cerchio.

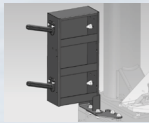

## ACCESSORI A RICHIESTA PER M 824 LL

Codice	Immagine	Descrizione
8-11120015		<b>REP-3S</b> Kit di 3 protezioni bordo cerchio corte.
8-11400293		<b>KPP-LL</b> Kit protezioni in plastica per torretta "LEVER-LESS". Per gli smontagomme fino alla matricola N°: FMG143250
8-11400325		<b>KPP-LL V3</b> Kit protezioni in plastica per torretta "LEVER-LESS". Per gli smontagomme a partire dalla matricola N°: FMG143251
8-11100296		<b>DRT 24</b> Kit dima regolazione torretta "LEVER-LESS".
8-11120095		<b>Kit</b> supporto grasso regolabile 1-5 Kg
8-11120092		<b>Kit</b> cassetta accessori universale
8-11100042		<b>GA69</b> Serie di attacchi per il bloccaggio dall'esterno dei cerchi 8"÷ 9".
8-11100041		<b>GA524</b> Serie di attacchi per aumentare +4" il bloccaggio dall'esterno.
8-11100036		<b>GM520</b> Serie attacchi ruote moto da 15" a 23" / 25".

# SMONTAGOMME TRADIZIONALI



## M 724S serie



ALLY 85  
DISPONIBILE A RICHIESTA

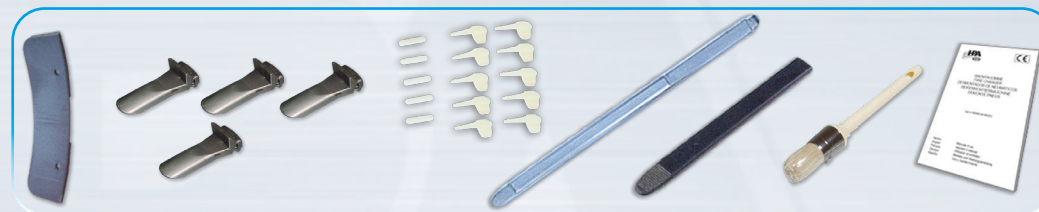

Tutti i modelli completi di:

- 1 Leva alzatalloni
- 1 Serie di 4 protezioni griffe per cerchi in lega (anteriori/posteriori)
- 1 Guaina in plastica per paletta stallonatore
- 1 Guaina in plastica per leva alzatalloni
- 1 Kit di inserti plastici per torretta (supplementari)
- 1 Pennello per lubrificante talloni
- 1 Manuali istruzioni

### M 724S

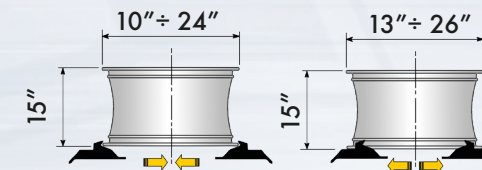

Codice	Alimentazione	Descrizione
0-11211201/25	400V/3Ph/50Hz	<b>M 724S</b>
0-11211202/25	200-230V/1Ph/50-60Hz	<b>M 724S 2V IP</b>
0-11211301/25	400V/3Ph/50Hz	<b>M 724S FS</b>
0-11211302/25	200-230V/1Ph/50-60Hz	<b>M 724S2V IP FS</b>
0-11211312/25	200-230V/1Ph/50	<b>M 724S FS</b>
0-11211206/25	12 V	<b>M 724S</b>
<b>Versioni con posizionamento utensili pneumatico</b>		
0-11211402/25	200-230V/1Ph/ 50-60Hz	<b>M 724S AUTOMATIC 2V IP</b>
0-11211502/25	200-230V/1Ph/ 50-60Hz	<b>M 724S AUTOMATIC 2V IP FS</b>



: Particolare NUOVO o MODIFICATO

# SMONTAGOMME TRADIZIONALI



## M 624 serie



Tutti i modelli completi di:

- 1 Leva alzatalloni
- 1 Serie di 4 protezioni griffe per cerchi in lega (anteriori/posteriori)
- 1 Guaina in plastica per paletta stallonatore
- 1 Guaina in plastica per leva alzatalloni
- 1 Kit di inserti plastici per torretta (supplementari)
- 1 Pennello per lubrificante talloni
- 1 Manuali istruzioni

### M 624

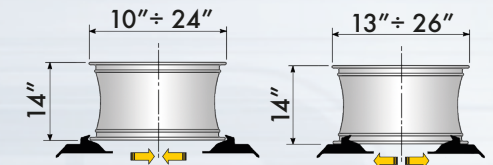

Codice	Alimentazione	Descrizione
0-11106322/25	230V/1Ph/50-60Hz	<b>M 624 2V FS</b> - Sistema "IP" (Increased Power System)
0-11106301/25	400V/3Ph/50Hz	<b>M 624 FS</b>
0-11106302/25	230V/1Ph/50Hz	<b>M 624 FS</b>
0-11106401/25	400V/3Ph/50Hz	<b>M 624</b>



: Particolare NUOVO o MODIFICATO



# SMONTAGOMME TRADIZIONALI



## M 522 serie



- Tutti i modelli completi di:
- 1 Leva alzataloni
  - 1 Serie di 4 protezioni griffe per cerchi in lega (anteriori/posteriori)
  - 1 Guaina in plastica per paletta stallonatore
  - 1 Guaina in plastica per leva alzataloni
  - 1 Kit di inserti plastici per torretta (supplementari)
  - 1 Pennello per lubrificante talloni
  - 1 Manuali istruzioni

### M 522

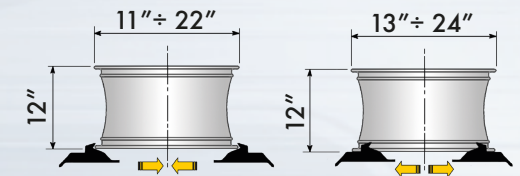

Codice	Alimentazione	Descrizione
0-11108441/25	400V/3Ph/50Hz	<b>M 522 2V FS</b>
0-11108401/25	400V/3Ph/50Hz	<b>M 522 FS</b>
0-11108341/25	400V/3Ph/50Hz	<b>M 522 2V</b>
0-11108301/25	400V/3Ph/50Hz	<b>M 522</b>



: Particolare NUOVO o MODIFICATO

# SMONTAGOMME TRADIZIONALI



## M 424 A serie



- Tutti i modelli completi di:
- 1 Leva alzatalloni
  - 1 Serie di 4 protezioni griffe per cerchi in lega (anteriori/posteriori)
  - 1 Guaina in plastica per paletta stallonatore
  - 1 Guaina in plastica per leva alzatalloni
  - 1 Kit di inserti plastici per torretta (supplementari)
  - 1 Pennello per lubrificante talloni
  - 1 Manuali istruzioni
  - 1 Pistola di gonfiaggio (\*)
- \*: Fornita solo per i modelli M 424 A 2V e M 424 A

### M 424 A

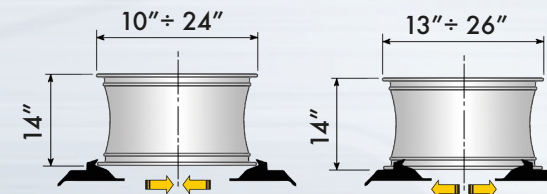

Codice	Alimentazione	Descrizione
0-11201641/25	400V/3Ph/50Hz	<b>M 424 A 2V FS</b>
0-11201601/25	400V/3Ph/50Hz	<b>M 424 A FS</b>
0-11201541/25	400V/3Ph/50Hz	<b>M 424 A 2V</b>
0-11201501/25	400V/3Ph/50Hz	<b>M 424 A</b>



: Particolare NUOVO o MODIFICATO

# SMONTAGOMME TRADIZIONALI



## M 424 serie



- Tutti i modelli completi di:
- 1 Leva alzatalloni
  - 1 Serie di 4 protezioni griffe per cerchi in lega (anteriori/posteriori)
  - 1 Guaina in plastica per paletta stallonatore
  - 1 Guaina in plastica per leva alzatalloni
  - 1 Kit di inserti plastici per torretta (supplementari)
  - 1 Pennello per lubrificante talloni
  - 1 Manuali istruzioni
  - 1 Pistola di gonfiaggio (\*)
- \*: Fornita solo per i modelli M 424 2V e M 424

### M 424

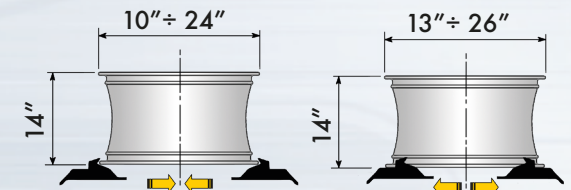

Codice	Alimentazione	Descrizione
0-11200841/25	400V/3Ph/50Hz	<b>M 424 2V FS</b>
0-11200801/25	400V/3Ph/50Hz	<b>M 424 FS</b>
0-11200741/25	400V/3Ph/50Hz	<b>M 424 2V</b>
0-11200701/25	400V/3Ph/50Hz	<b>M 424</b>



: Particolare NUOVO o MODIFICATO



# SMONTAGOMME TRADIZIONALI



## M 422 serie



- Tutti i modelli completi di:
- 1 Leva alzataloni
  - 1 Kit di inserti plastici per torretta (supplementari)
  - 1 Pennello per lubrificante talloni
  - 1 Manuali istruzioni
  - 1 Pistola di gonfiaggio (\*)
- \*: Fornita solo per i modelli M 422 2V e M 422

### M 422

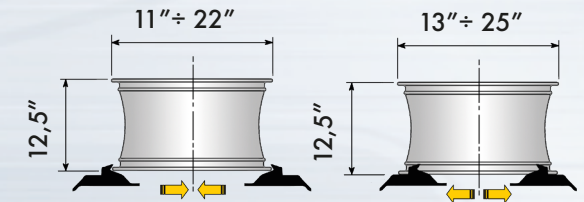

Codice	Alimentazione	Descrizione
0-11210941/25	400V/3Ph/50Hz	<b>M 422 2V FS</b>
0-11210901/25	400V/3Ph/50Hz	<b>M 422 FS</b>
0-11211041/25	400V/3Ph/50Hz	<b>M 422 2V</b>
0-11211001/25	400V/3Ph/50Hz	<b>M 422</b>



: Particolare NUOVO o MODIFICATO

## ACCESSORI A RICHIESTA PER SMONTAGOMME LEGGERI (TUTTI)

### Dispositivi complementari

Codice	Immagine	Descrizione
8-15100033		<b>Dispositivo</b> INDUSTRIA 4.0
6015001300		<b>TPM-02</b> Strumento di diagnosi sensori TPMS.
8-64500013		<b>Kit OBD.</b>
6015001391		<b>TPM-02 Plus</b> <b>TPM-02 + kit OBD.</b>
6015001360		<b>TPM-02</b> Stampante bluetooth.

## ACCESSORI A RICHIESTA PER SMONTAGOMME LEGGERI (TUTTI)

### Dispositivi complementari

Codice	Immagine	Descrizione
8-51100029		<b>TPM-02</b> Abbonamento annuale standard.
8-51120003		<b>TPM-02</b> Abbonamento annuale esteso.
8-51120001		<b>TPM-02 + EOBD</b> Abbonamento annuale.
8-51120004		<b>TPM-02 + EOBD</b> Abbonamento annuale esteso.
8-51120006		<b>Servizio opzionale</b> di installazione strumento.



# ACCESSORI A RICHIESTA PER SMONTAGOMME LEGGERI TRADIZIONALI

Codice	Immagine	Descrizione	M 724 S	M 624 serie	M 522 serie	M 424 serie	M 422 serie
8-11400211		<b>ALLY 80</b> Accessorio universale alza/premitallone "a dischi".		●	●		
8-11200003		<b>ALLY 85</b> Accessorio multifunzione alza/premitallone.				●	
8-11100451		<b>ALLY 85</b> Accessorio multifunzione alza/premitallone.	●				

## ACCESSORI A RICHIESTA PER SMONTAGOMME LEGGERI TRADIZIONALI

Codice	Immagine	Descrizione	M 724 S	M 624 serie	M 522 serie	M 424 serie	M 422 serie
8-11100343		<b>ALLY 30</b> Accessorio univ. alza/premitallone a tre bracci operanti.	●	●	●	●	●
8-11100363		<b>ALLY 30 Kit di installazione</b> e personalizzazione per M 624 e M 522.		●	●		
8-11200004		<b>ALLY 30 Kit di installazione</b> e personalizzazione per Serie M 424.					●
8-11220006		<b>ALLY 30 Kit di installazione</b> e personalizzazione per Serie M 422					●
8-11120019		<b>ALLY 30 Kit di installazione</b> e personalizzazione per M 724 S.		●			
8-11400058		<b>EFS70/W</b> Gonfiatore elettronico per installazione a muro.	●	●	●	●	
8-11100243		<b>KWL 80</b> Dispositivo pneumatico di sollevamento ruota. Portata: 80 kg.	●	●	●		

# ACCESSORI A RICHIESTA PER SMONTAGOMME LEGGERI TRADIZIONALI

Codice	Immagine	Descrizione	M 724 S	M 624 serie	M 522 serie	M 424 serie	M 422 serie
8-11220007		<b>KWL 60</b> Dispositivo pneumatico di sollevamento ruota. Portata: 60 kg.				●	●
8-51120007		<b>Pistoletta di gonfiaggio</b> Asturo BAR/PSI				●	
801276833		<b>PGM</b> Pistola di gonfiaggio Michelin manometro in BAR - Omol. CE.			●		
801281796		<b>PGE</b> Pistola di gonfiaggio economica manometro in BAR - Omol. CE.			●		
801262417		<b>PPT</b> Pinza premitallone per pneumatici "Run Flat" - Approvato WDK.	●	●	●	●	●
801435685		<b>UPT</b> Utensile premitallone universale.	●	●	●	●	●



# ACCESSORI A RICHIESTA PER SMONTAGOMME LEGGERI TRADIZIONALI

Codice	Immagine	Descrizione	M 724 S	M 624 serie	M 522 serie	M 424 serie	M 422 serie
8-11400290		<b>PTR</b> Premitallone a rulli per pneumatici "Run Flat" e UHP.	●	●	●	●	●
8-11100042		<b>GA69</b> Serie di attacchi per il bloccaggio dall'esterno dei cerchi 8"÷ 9".	●	●	●	●	●
8-11100041		<b>GA524</b> Serie di attacchi per aumentare +4" il bloccaggio dall'esterno.	●	●	●	●	●
8-11100036		<b>GM520</b> Serie attacchi ruote moto da 15" a 23" / 25".	●	●	●	●	●
8-11120027		<b>Kit</b> paletta stallonatore moto universale	●	●	●	●	●
8-11100044		<b>PCL54</b> Serie di 12 protezioni integrali per il bloccaggio dei cerchi in lega.	●	■	■	■	●

## ACCESSORI A RICHIESTA PER SMONTAGOMME LEGGERI TRADIZIONALI

Codice	Immagine	Descrizione	M 724 S	M 624 serie	M 522 serie	M 424 serie	M 422 serie
801246241		<b>KGL6</b> Kit di 6 guaine in plastica per leva alzatalloni.	■	■	■	■	●
801254341		<b>PS10</b> Kit di 10 inserti salvacerchio in plastica per torretta utensili.		■	■	■	■
801258898		<b>PTH5</b> Kit di 5 pastiglie salva cerchio in plastica per torretta utensili.		■	■	■	■
801458663		<b>PTS60</b> Protezione plastica per tampone stallonatore laterale.				●	●
801258383		<b>GPS60</b> Kit di 6 guaine in plastica per paletta stallonatore.	■	■	■	■	●
8-11120050		<b>TAM/WING</b> Torretta in ferro auto/moto completa (dalla matricola # FRD267085)	■			●	●

## ACCESSORI A RICHIESTA PER SMONTAGOMME LEGGERI TRADIZIONALI

Codice	Immagine	Descrizione	M 724 S	M 624 serie	M 522 serie	M 424 serie	M 422 serie
8-11100369		<b>MPK5</b> kit di 10+10 protezioni in plastica per torretta TAM/WING	●			●	●
801250309		<b>TCL40</b> Torretta utensili in materiale plastico.		●	●		
8-11400329		<b>TPA-Wing</b> - Kit torretta completa in plastica con adattatore (a partire dalla matricola # FRD267085)	●			●	●
8-11400334		<b>TPA-Wing</b> - Kit torretta completa in plastica con adattatore (fino alla matricola # FRD267085 esclusa) Per M 522 e M 624 sempre installabile.	●	●	●	●	●
8-11400330		<b>TPA-Wing</b> torretta in plastica singola	●			●	●
8-11100378		<b>TMN</b> Torretta per ruote scooter. Completa di protezioni in plastica per cerchi in lega (dalla matricola # FRD267085)	●			●	●
8-11100370		<b>MPK6</b> Serie di protezioni per nuova torretta (per TMN scooter).					
801252083		<b>Kit torretta</b> ruote scooter da 8" (fino alla matricola # FRD267084)		●	●		



# ACCESSORI A RICHIESTA PER SMONTAGOMME LEGGERI TRADIZIONALI

Codice	Immagine	Descrizione	M 724 S	M 624 serie	M 522 serie	M 424 serie	M 422 serie
8-11100001		<b>Kit innesto rapido torretta</b> (fino alla matricola # FRD267084)		●	●		
8-11120089		<b>Kit cambio rapido torretta</b> (a partire dalla matricola # FRD267085)	●			●	●
8-11120014		<b>REP-3</b> Kit di 3 protezioni bordo cerchio.	●	●	●	●	
8-11120015		<b>REP-3S</b> Kit di 3 protezioni bordo cerchio corte.	●	●	●	●	
8-11120028/90		<b>PWR</b> Kit rulliera a pavimento per stallonatore.	●	●	●	●	
8-11120095		<b>Kit supporto</b> grasso regolabile 1-5 Kg	●	●	●	●	
8-11120092		<b>Kit cassetta</b> accessori universale		●	●		

# SMONTAGOMME LEGGERI MOTO



## M 322 BIKE



Tutti i modelli completi di:

- 1 Leva tallone
- 1 Set di inserti in plastica per testa utensili (aggiuntivi)
- 1 Spazzolino per lubrificazione tallone
- 1 Manuale dell'operatore
- Pistola di gonfiaggio 1 BAR/PSI (\*)

\*: Fornito solo per i modelli M 322.

## M 322 BIKE

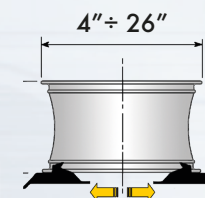

Codice	Alimentazione	Descrizione
0-11211601/25	400V/3Ph/50Hz	<b>M 322 BIKE</b>
0-11211602/25	230V/3Ph/50Hz	<b>M 322 BIKE</b>
0-11211603/25	230V/1Ph/50Hz	<b>M 322 BIKE</b>



: Particolare NUOVO o MODIFICATO

## ACCESSORI A RICHIESTA PER M 322 BIKE

Codice	Immagine	Descrizione
8-11100461		<b>Kit griffe</b> autocentrante moto racing 8"-26"
8-11100462		<b>Kit griffe</b> autocentrante ATV 5"-18"
8-11100463		<b>Piattaforma rimovibile</b> per ruota moto
8-11120032		<b>Helper BPL</b>



## ACCESSORI A RICHIESTA PER M 322 BIKE

Codice	Immagine	Descrizione
801254341		<b>PS10</b> Kit di 10 inserti salvacerchio in plastica per torretta utensili.
801258898		<b>PTH5</b> Kit di 5 pastiglie salva cerchio in plastica per torretta utensili.
8-11400329		<b>TPA-Wing</b> - Kit torretta completa in plastica con adattatore (a partire dalla matricola # FRD267085)
8-11400330		<b>TPA-Wing</b> torretta in plastica singola
8-11100378		<b>TMN</b> Torretta per ruote scooter. Completa di protezioni in plastica per cerchi in lega (dalla matricola # FRD267085)
8-11120089		<b>Kit</b> cambio rapido torretta (a partire dalla matricola # FRD267085)

# SMONTAGOMME LEGGERI MOTO



## M 200 BIKE



Tutti i modelli completi di:

- 1 Leva alzatalloni
- 1 Guaina in plastica per leva alzatalloni
- 1 Guaina in plastica per paletta stallonatore
- 1 Serie di 4 adattatori in plastica per ruote go-kart
- 1 Kit di inserti plastici per torretta (supplementari)
- 1 Pennello per lubrificante talloni
- 1 Pistola di gonfiaggio
- 1 Manuali istruzioni

### M 200 BIKE

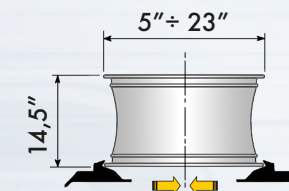

Codice	Alimentazione	Descrizione
0-11613401/25	230V/1Ph/50Hz	<b>M 200 BIKE</b>
0-11613405/25	400V/3Ph/50Hz	<b>M 200 BIKE</b>
0-11613414/25	115V/1Ph/60Hz	<b>M 200 BIKE</b>



: Particolare NUOVO o MODIFICATO

## ACCESSORI A RICHIESTA PER M 200 BIKE

Codice	Immagine	Descrizione
8-11600020		<b>PPM</b> Kit di 6 guaine in plastica per paletta stallonatore.
8-11600116		<b>SR</b> Kit braccetto appoggio ruote.
8-11600117		<b>PR</b> Kit rullo di montaggio ruote piccole inferiori a 8".
8-11600118		<b>UCA</b> Serie di 4 attacchi per ruote cross.
8-11600119		<b>ATV A</b> Serie di 4 adattatori per ruote QUADS (da 6" a 16")
8-11600121		<b>CKM</b> Serie di 4 griffe di bloccaggio.



## ACCESSORI A RICHIESTA PER M 200 BIKE

Codice	Immagine	Descrizione
8-11600120		<b>ATV C</b> Kit centraggio per ruote quads (solo con braccetto portaruota SR).
8-11600122		<b>GKS</b> Serie di protezioni in plastica.
8-11600123		<b>GK</b> Serie di 4 adattatori per ruote go-kart.
8-11600124		<b>PO</b> Kit portaoggetti
8-11600125		<b>TG1</b> Secchiello grasso lubrificante da 1 kg.
8-11600126		<b>IG</b> Pistola di gonfiaggio con manometro in BAR. Omologata CE

# SMONTAGOMME PESANTI



## F 565



Stand by

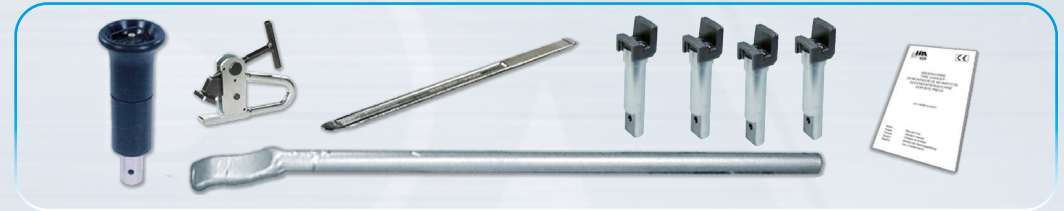

- Completo di:
- 1 Set 4 griffe 60"
  - 1 Rullo tubeless
  - 1 Leva alzatalloni
  - 1 Leva per cerchietti
  - 1 Pinza per cerchioni
  - 1 Manuale istruzioni

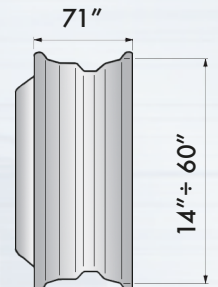

## F 565

Codice	Alimentazione	Descrizione
0-12455001/25	400V/3Ph/50Hz	<b>F 565</b>
0-12455002/25	230V/3Ph/60Hz	<b>F 565</b>



: Particolare NUOVO o MODIFICATO

# SMONTAGOMME PESANTI



## F 562

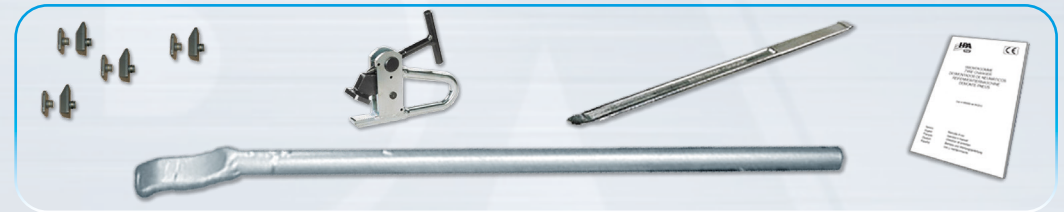

- Completo di:
- 1 Leva alzatalloni
  - 1 Leva per cerchietti
  - 1 Pinza per cerchi
  - 1 Sacchetto tasselli griffa (4+4 pz.)
  - 1 Manuale istruzioni

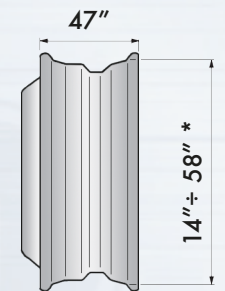

\*: con prolunghe PA4V

### F 562

Codice	Alimentazione	Descrizione
0-12440126/25	400V/3Ph/50Hz	F 562



: Particolare NUOVO o MODIFICATO



# SMONTAGOMME PESANTI



## F 562 M



- Completo di:
- 1 Leva alzatalloni
  - 1 Leva per cerchiati
  - 1 Pinza per cerchiati
  - 1 Sacchetto tasselli griffa (4+4 pz.)
  - 1 Manuale istruzioni

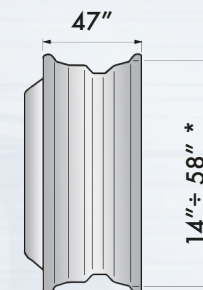

\*: con prolunghe PA4V

### F 562 M

Codice	Alimentazione	Descrizione
0-12400701/25	400V/3Ph/50Hz	F 562 M



: Particolare NUOVO o MODIFICATO

# SMONTAGOMME PESANTI



## F 560 A Special F 560 Special



- Completo di:  
 1 Kit 4 prolunghe 56"  
 1 Leva alzatalloni  
 1 Leva per cerchietti  
 1 Pinza per cerchioni  
 1 Manuale istruzioni

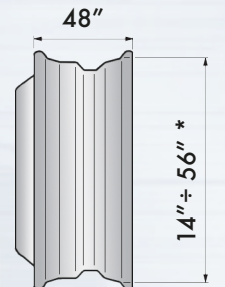

\*: con prolunghe KP56

### F 560 - F 560 A SPECIAL

Codice	Alimentazione	Descrizione
0-12453005/25	400V/3Ph/50Hz	<b>F 560 A SPECIAL</b>
0-12453001/25	400V/3Ph/50Hz	<b>F 560 SPECIAL</b>



: Particolare NUOVO o MODIFICATO



# SMONTAGOMME PESANTI



## F 560 A Special Y F 560 Special Y

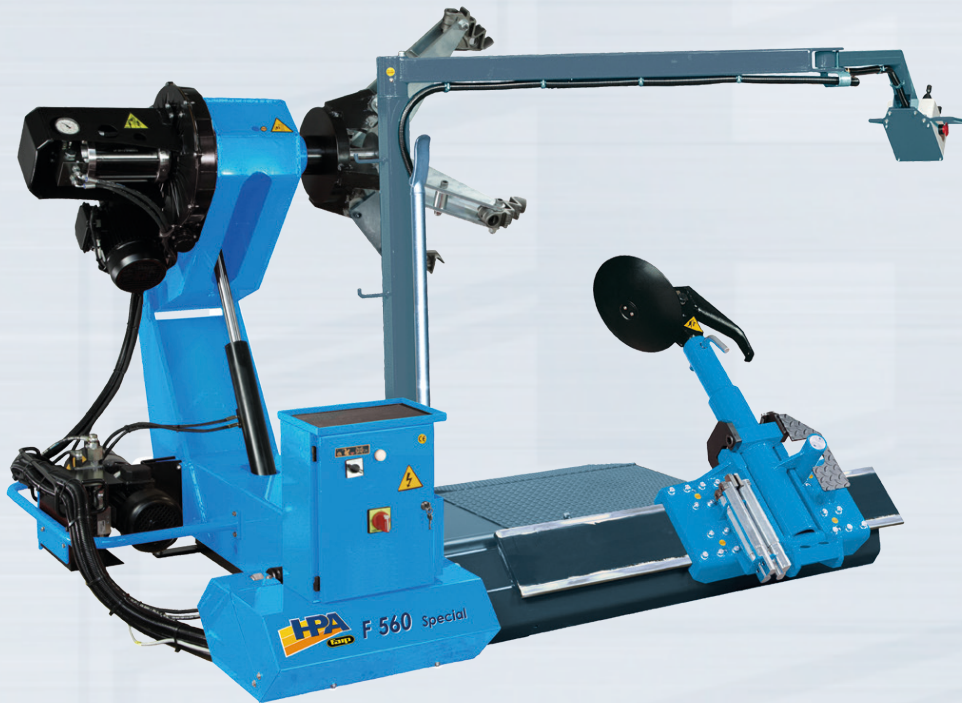

- Completo di:  
 1 Kit 4 prolunghe 56"  
 1 Leva alzatalloni  
 1 Leva per cerchi  
 1 Pinza per cerchi  
 1 Manuale istruzioni

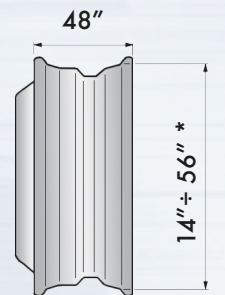

\*: con prolunghe KP56

### F 560 - F 560 A SPECIAL Y

Codice	Alimentazione	Descrizione
0-12453007/25	400V/3Ph/50Hz	<b>F 560 A SPECIAL Y</b>
0-12453003/25	400V/3Ph/50Hz	<b>F 560 SPECIAL Y</b>



: Particolare NUOVO o MODIFICATO



# SMONTAGOMME PESANTI



## F 560 A

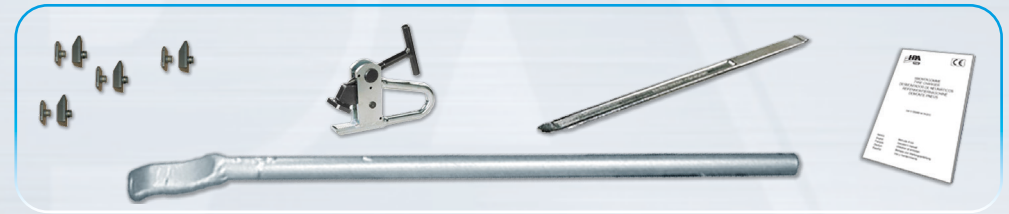

- Completo di:
- 1 Leva alzatalloni
  - 1 Leva per cerchietti
  - 1 Pinza per cerchioni
  - 1 Sacchetto tasselli griffa (4+4 pz.)
  - 1 Manuale istruzioni

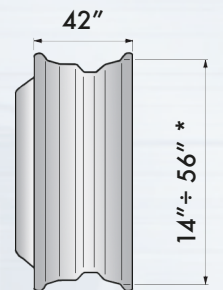

\*: con prolunghe PA4V

### F 560 A

Codice	Alimentazione	Descrizione
0-12200501/25	400V/3Ph/50Hz	F 560 A



: Particolare NUOVO o MODIFICATO

# SMONTAGOMME PESANTI



## F 560

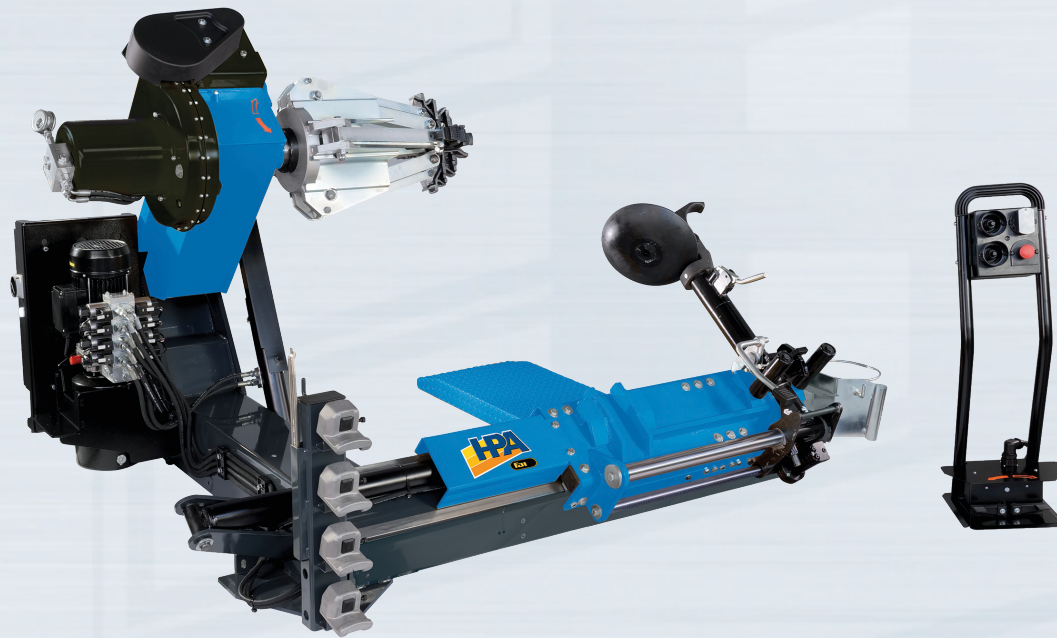

- Completo di:
- 1 Leva alzatalloni
  - 1 Leva per cerchiati
  - 1 Pinza per cerchiati
  - 1 Sacchetto tasselli griffa (4+4 pz.)
  - 1 Manuale istruzioni

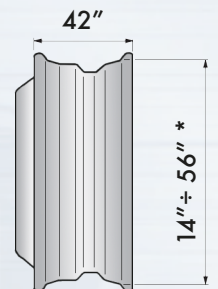

\*: con prolunghe PA4V

## F 560

Codice	Alimentazione	Descrizione
0-12200401/25	400V/3Ph/50Hz	F 560



: Particolare NUOVO o MODIFICATO



# SMONTAGOMME PESANTI



## F 260

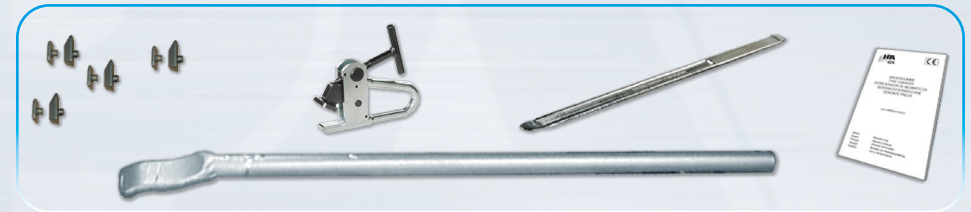
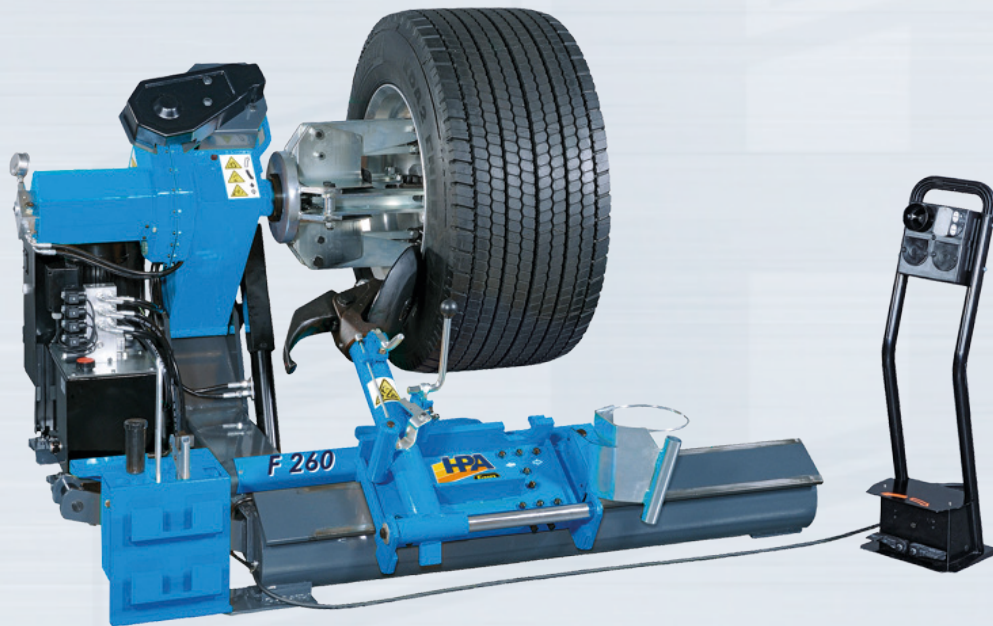

Completo di:  
1 Leva alzattoloni  
1 Leva per cerchi  
1 Pinza per cerchi  
1 Sacchetto tasselli griffa (4+4 pz.)  
1 Manuale istruzioni

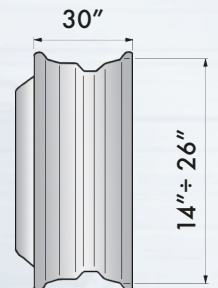

## F 260

Codice	Alimentazione	Descrizione
0-12423019/25	400V/3Ph/50Hz	F 260

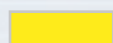

 : Particolare NUOVO o MODIFICATO



# SMONTAGOMME PESANTI



## F 240 A

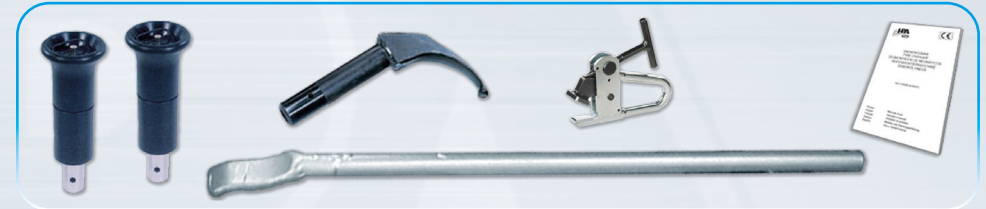
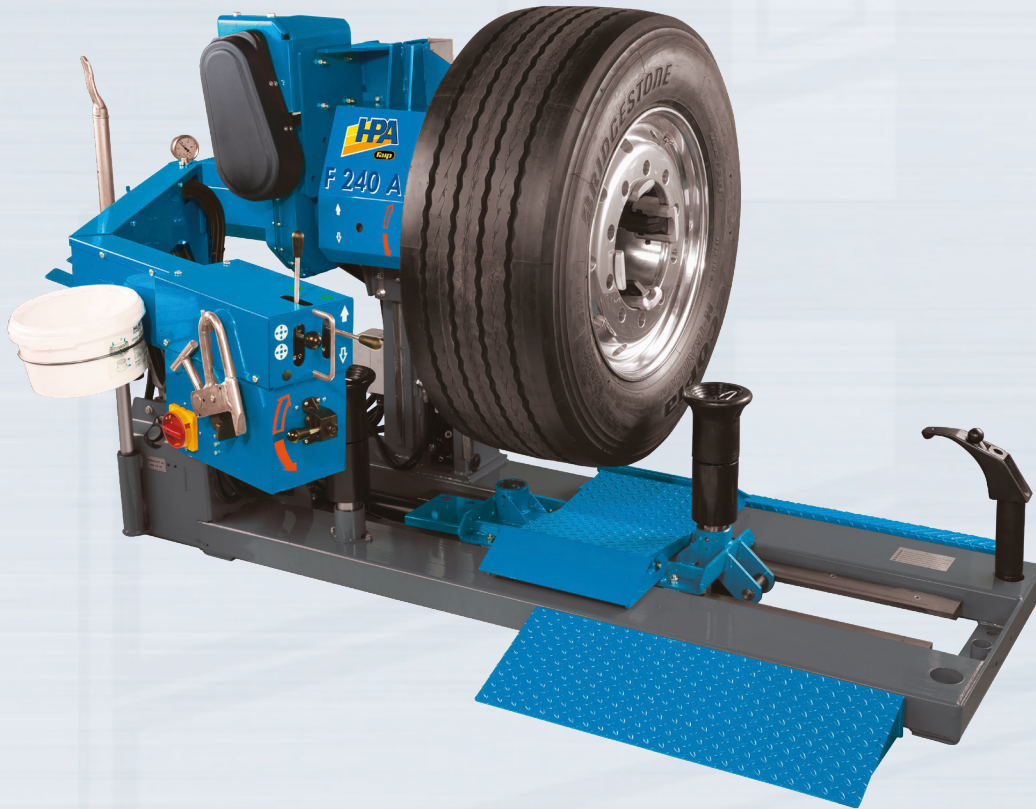

Completo di:  
 2 Rulli per tubeless  
 1 Utensile a becco  
 1 Leva alzatalloni  
 1 Pinza per cerchi  
 1 Manuale istruzioni

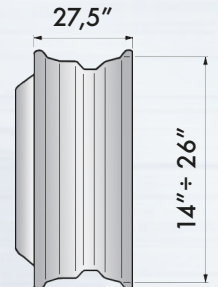

### F 240 A

Codice	Alimentazione	Descrizione
0-12200105/25	400V/3Ph/50Hz	<b>F 240 A</b>
0-12200107/25	230V/1Ph/50Hz	<b>F 240 A</b>



: Particolare NUOVO o MODIFICATO

# SMONTAGOMME PESANTI



## F 230 Mobile

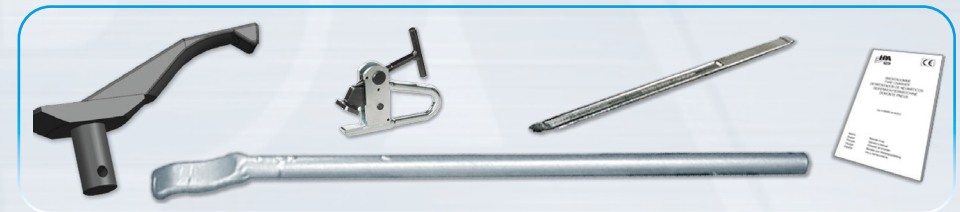

- Completo di:
- 1 Utensile a becco
  - 1 Leva alzatalloni
  - 1 Leva per cerchietti
  - 1 Pinza per cerchioni
  - 1 Manuale istruzioni

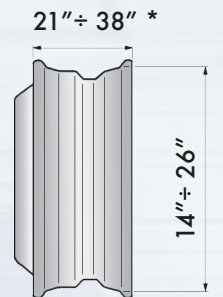

\*: Variabile in base alla geometria del cerchio

### F 230 MOBILE

Codice	Alimentazione	Descrizione
0-12200301/25	400V/3Ph/50Hz	<b>F 230</b> Mobile per installazione su furgoni - Completo di generatore.
0-12200201/25	400V/3Ph/50Hz	<b>F 230</b> Mobile per installazione su furgoni - Senza generatore.



: Particolare NUOVO o MODIFICATO



# SMONTAGOMME PESANTI



## F 226 Mobile



- Completo di:
- 1 Leva alzatalloni ruote auto
  - 1 Leva alzatalloni ruote camion
  - 1 Leva per cerchietti
  - 2 Guaina per leva alzatalloni
  - 1 Serie adattatori bloccaggio cerchi in lega
  - 1 Accessorio per auto / furgoni
  - 1 Pinza per cerchioni
  - 1 Pennello piatto
  - 1 Pompa manuale per ingrassaggio
  - 1 Manuale istruzioni

20" ÷ 37" \*

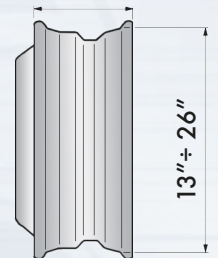

\*: Variabile in base alla geometria del cerchio

### F 226 MOBILE

Codice	Alimentazione	Descrizione
0-12101901/16	380V/3Ph/50Hz	<b>F 226 Mobile</b> RAL 3002 per installazione su furgoni - Completo di generatore.
0-12102201/16	380V/3Ph/50Hz	<b>F 226 Mobile</b> RAL 3002 per installazione su furgoni - Senza di generatore.
8-12100003		<b>Kit di personalizzazione</b>



: Particolare NUOVO o MODIFICATO



## ACCESSORI A RICHIESTA PER SMONTAGOMME PESANTI

Codice	Immagine	Descrizione	F 565	F 562 - F 562 M	F 560 Special	F 560 A . F 560	F 260	F 240 A	F 230 Mobile	F 226 Mobile
8-12120027		<b>Dispositivo</b> INDUSTRIA 4.0	●	●	●	●			●	
8-12100039/25		<b>PC240</b> Pedana carrello orizzontale						●		
8-12100040/25		<b>PT240</b> Pedana telaio laterale						●		
8-12400014		<b>Radio comando TROLLEY</b> multicanale 2.4 GHz. Tecnologia PLC. Compatibile fino alla matricola FUC272747		●						
8-12120025/00		<b>Radio comando</b> per F560, F560A, F562 e F562 M F 560 A/F 560 compatibile a partire dalla matricola: FRCxxxxxx F 562 compatibile a partire dalla matricola: FUDxxxxxx		●		●				

## ACCESSORI A RICHIESTA PER SMONTAGOMME PESANTI

Codice	Immagine	Descrizione	F 565	F 562 - F 562 M	F 560 Special	F 560 A . F 560	F 260	F 240 A	F 230 Mobile	F 226 Mobile
8-12100026		<b>SGP</b> Radio comando (per F 560 A Special e F 560 Special Y).			●					
801271597		<b>MV50/2</b> Coppia di morsetti con vite.	●	●	●	●	●			
801271609		<b>RT50/2</b> Rullo per tubeless.				●	●			
801280918		<b>RT56</b> Rullo per tubeless.		●						
19120014		<b>RT</b> Rullo per tubeless.			●					
19120016		<b>RT56 Y</b> Rullo per tubeless con cuscinetti. Alte prestazioni			●					
8-12100156		<b>GL4V</b> kit di 4 griffe per cerchi in lega per nuove griffe autocentrante "4V" (per F240A a partire dalla matricola FRE300447)		●		●	●	●		
8-12100175		<b>KGL56</b> Serie di 4 griffe per cerchi in lega.	●		●					

## ACCESSORI A RICHIESTA PER SMONTAGOMME PESANTI

Codice	Immagine	Descrizione	F 565	F 562 - F 562 M	F 560 Special	F 560 A . F 560	F 260	F 240 A	F 230 Mobile	F 226 Mobile
801227195		<b>PL56</b> Pinza per cerchi in lega.	●	●	●	●	●	●	●	●
8-12100155		<b>PA4V</b> Serie di 4 prolunghe autocentrante con nuove griffe "4V".		●		●				
8-12100171	 x4	<b>P4P</b> Serie di 4 prolunghe a 4 punti per cerchi con cerchietto.	●		●					
8-12100172		<b>SPIG</b> Serie di 8 + 8 inserti plastici di ricambio per nuove griffe autocentrante "4V".		■		■	■			
8-11400200		<b>SPI</b> Serie di 4 + 4 + 4 inserti plastici di ricambio per griffe per cerchi in lega KGL56.	■		■					
8-12100176		<b>PA26</b> Serie di 4 prolunghe per autocentrante (per F240A fino alla matricola FRE300446)						●	●	
801254494		<b>PCL26</b> Serie di 4 protezioni cerchi in lega (per F240A fino alla matricola FRE300446)						●	●	



## ACCESSORI A RICHIESTA PER SMONTAGOMME PESANTI

Codice	Immagine	Descrizione	F 565	F 562 - F 562 M	F 560 Special	F 560 A . F 560	F 260	F 240 A	F 230 Mobile	F 226 Mobile
8-12100188		<b>Kit prolunghe</b> cerchi gru portuali	●		●	●				
8-12100005		<b>AB164</b> Adattatore bloccaggio cerchi in lega D.164.	●	●	●	●	●	●	●	●
8-12100006		<b>AB176</b> Adattatore bloccaggio cerchi in lega D.176.	●	●	●	●	●	●	●	●
8-12100007		<b>AB161</b> Adattatore bloccaggio cerchi in lega D.161.	●	●	●	●	●	●	●	●
8-12100008		<b>AB202</b> Adattatore bloccaggio cerchi in lega D.202.	●	●	●	●	●	●	●	●
8-12300001		<b>AB220</b> Adattatore bloccaggio cerchi in lega D.220.	●	●	●	●	●	●	●	●
8-12100009		<b>AB221</b> Adattatore bloccaggio cerchi in lega D.221.	●	●	●	●	●	●	●	●
8-12100010		<b>AB281</b> Adattatore bloccaggio cerchi in lega D.281.	●	●	●	●	●	●	●	●
801217615		<b>LA24</b> Leva alzatalloni.	■	■	■	■	■	■	■	■
801417620		<b>LC24</b> Leva per cerchietti.	■	■	■	■	■	●	■	■

## ACCESSORI A RICHIESTA PER SMONTAGOMME PESANTI

Codice	Immagine	Descrizione	F 565	F 562 - F 562 M	F 560 Special	F 560 A . F 560	F 260	F 240 A	F 230 Mobile	F 226 Mobile
801251904		<b>Morsetto</b> di montaggio per ruote skidder	●	●	●	●	●	●		
8-12100044		<b>Kit protezione</b> parabordo (3 Pezzi)	●	●	●	●	●	●	●	●
801289439		<b>RT24</b> Rullo per tubeless.	■					■		
801289440		<b>UB24</b> Utensile a becco.						■		
801289441		<b>DS24</b> Disco stallonatore.						●		
8-12100030		<b>DS226</b> Disco stallonatore per cerchi per F 226 Mobile.							●	●

## ACCESSORI A RICHIESTA PER SMONTAGOMME PESANTI

Codice	Immagine	Descrizione	F 565	F 562 - F 562 M	F 560 Special	F 560 A . F 560	F 260	F 240 A	F 230 Mobile	F 226 Mobile
8-12100157		<b>K4V26</b> Kit 4 griffe 4V e bielle per aggiornamento F 260.					●			
8-12100158		<b>K4V56</b> Kit 4 griffe 4V per aggiornamento F 560 e F 560 A.				●				
8-12100159		<b>K4V58</b> Kit 4 griffe 4V per aggiornamento F 561 e F 562.			●					
8-12100017		<b>BP 120</b> Premi tallone pneumatico.	●	●	●	●	●	●	●	●
8-11400034		<b>SGG</b> Vaso porta grasso con pennello (4 kg).	●	●	●	●	●	●		●
801280917		<b>PS56</b> Pedana supplementare.		●						
8-12120023/90		<b>Kit pedana H=110.</b>	●							



## ACCESSORI A RICHIESTA PER SMONTAGOMME PESANTI

Codice	Immagine	Descrizione	F 565	F 562 - F 562 M	F 560 Special	F 560 A . F 560	F 260	F 240 A	F 230 Mobile	F 226 Mobile
8-12120020		<b>Radio comando</b> 2.4 GHz.							●	
8-12120024		<b>Kit upgrade</b> Radio comando per F230 Mobile indispensabile per smontagomme prodotti prima della matricola FPM182480							●	
8-12120008/90		<b>CAR MATE</b> per veicoli leggeri. Completo di accessorio con torretta utensili e disco.							●	
8-12120011/90		<b>Rulliera</b>							●	
8-12120009		<b>Prolunga per estensione</b> soglia di carico H=750 mm.							●	
8-12120010		<b>Prolunga per estensione</b> soglia di carico H=1.000 mm.							●	

# TABELLA PESI DIMENSIONI IMBALLI MACCHINE

## SMONTAGOMME LEGGERI

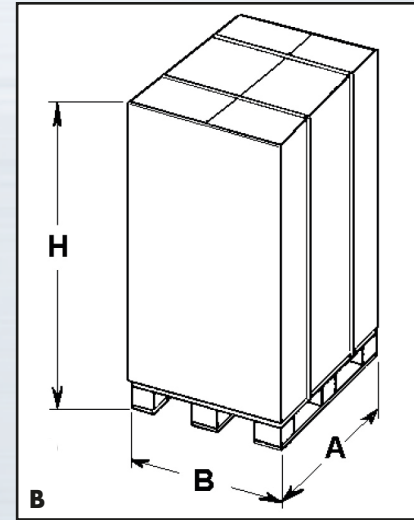
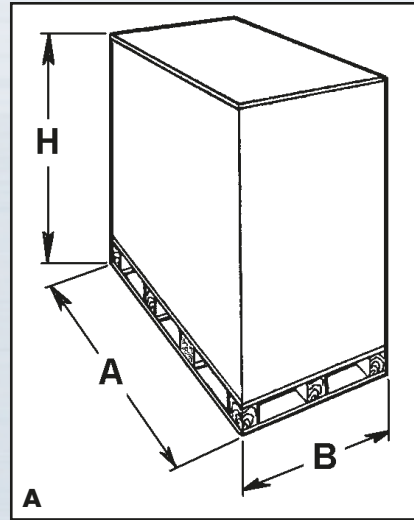

Modello	Tipo Imballo	Dimensioni (cm.) (A x B x H)	Peso Netto(kg)	Peso Lordo (kg)
<b>M 1032 (versione STD)</b>	Cassa in legno (A)	115x195x210	500	600
<b>M 928 ROYAL</b>	"	154x114x190	400	490
<b>M 830 LL+KWL</b>	"	132x 76x183	320	365
<b>M 824 2V FS LL</b>	"	90x115x 97	278	305
<b>M 824 LL</b>	"	90x115x 97	263	295
<b>M 624 2V FS</b>	"	99x112x102	260	290
<b>M 624</b>	"	99x112x102	245	275
<b>M 522 2V FS / M 522 FS</b>	"	99x112x102	240	270
<b>M 522 2V / M 522</b>	"	99x112x102	225	255
<b>M 424 2V FS / M 424 FS</b>	"	114x 76x 97	250	275
<b>M 424 2V / M 424</b>	"	114x 76x 97	235	260
<b>M 422 2V FS / M 422 FS</b>	Cartone pallettizzato (B)	112x100x 97	225	250
<b>M 422 2V / M 422</b>	"	112x100x 97	215	240
<b>M 200 BIKE</b>	"	95x115x108	155	175

Modello	Tipo Imballo	Dimensioni (cm.) (A x B x H)	Peso Netto(kg)	Peso Lordo (kg)
<b>Accessorio ALLY 80</b>	"	47x154x 45	105	120
<b>Accessorio ALLY 30 *</b>	Cartone pallettizzato	82x120x 42	70	110
<b>Accessorio ALLY 30 **</b>	"	53x120x 42	70	110

\*: Accessorio con braccio preassemblato

\*\* : Accessorio senza braccio preassemblato

## TABELLA PESI DIMENSIONI IMBALLI MACCHINE

### SMONTAGOMME PESANTI

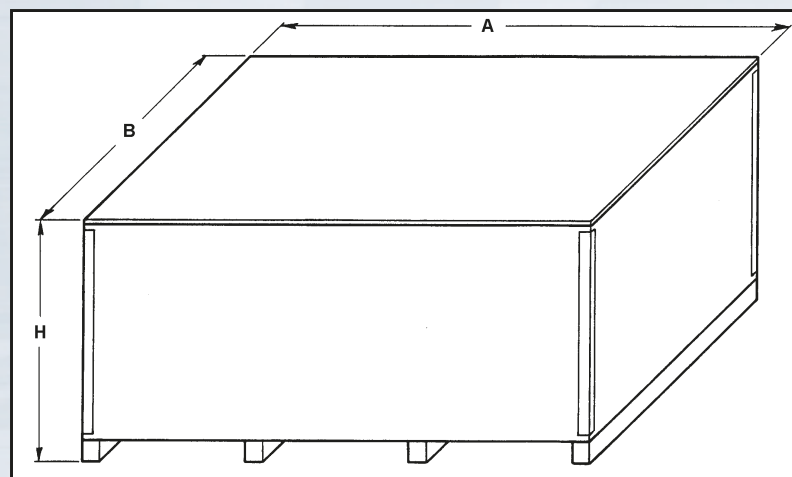

Modello	Tipo Imballo	Dimensioni (cm.) (A x B x H)	Peso Netto(kg)	Peso Lordo (kg)
<b>F 565</b>	Cassa in legno	299x229x110	2500	2200
<b>F 562</b>	"	272x231x105	1410	1610
<b>F 560 A</b>	"	212x192x110	750	910
<b>F 560</b>	"	200x172x103	740	870
<b>F 260</b>	"	200x172x103	510	640
<b>F 240 A</b>	"	193x76x109	500	540



# CONDIZIONI GENERALI DI VENDITA

- Il presente Listino Prezzi ITALIA copre le apparecchiature di produzione standard e annulla e sostituisce tutti i precedenti.
- I materiali sono resi FRANCO DOMICILIO DESTINATARIO con assicurazione coperta dal mittente.
- L'imballo standard è incluso nel prezzo di ogni prodotto.
- Al momento dell'ordinazione, indicare sempre il modello, la quantità, l'alimentazione (V, PH, Hz) richiesta.
- Condizioni di garanzia: 12 mesi dalla data di installazione, ma non più di 18 mesi dalla data della fattura di NEXION S.p.A.
- La garanzia non copre difetti o danni dovuti a installazione o utilizzo impropri dei prodotti, manutenzione inadeguata o conoscenza incompleta dei manuali forniti con i prodotti stessi.
- Qualsiasi restituzione della merce deve essere sempre autorizzata da NEXION S.p.A. Il trasporto merci è a rischio del mittente.
- NEXION S.p.A. si riserva il diritto di modificare le specifiche dei prodotti in qualsiasi momento senza preavviso o obbligo.

## AVVISO!

Per altre condizioni, fare riferimento al "Contratto di distribuzione".



**AZIENDA CON  
SISTEMA DI QUALITA'  
CERTIFICATO  
- ISO 9001-**

